

JWL[®]

JWJ Comercial México



CATÁLOGO ILUMINACIÓN LED

GLOSARIO DE SÍMBOLOS Y NOMENCLATURAS

Luz cálida
2700K

Luz neutra
4000K

Luz fría
6500K

Temperatura de Color

Luz Cálida: Crea un ambiente íntimo y acogedor. Se recomienda en tiendas de ropa, cafeterías, panaderías etc. En hogares se recomienda en salas, comedores y dormitorios.

Luz Neutra: Es la luz "más natural", intermedia entre la cálida y la fría, por lo que permite destacar e iluminar toda una zona sin alterar la vista.

Luz Fría: Equivale a la luz de un día muy soleado. Genera una percepción de mayor luminosidad. Recomendada para oficinas, pescaderías y joyerías. En viviendas, es habitual encontrarlo en cocinas y baños.

RGB: (Rojo, Verde, Azul). Las luminarias con LED RGB combinan estos tres colores para producir aprox. 16 millones de tonos de luz.

DC(corriente directa): Es una corriente constante, no varía el voltaje, se mantiene con respecto a la dirección y el tiempo.

CA(corriente alterna): Es una corriente eléctrica, en la que la dirección del flujo de electrones va y viene a intervalos regulares o en ciclos.

lm (Lumenes): Flujo luminoso que sale de una fuente de luz y que incide en un cuerpo sólido a 1m de distancia.



Este valor permite controlar la intensidad de luz de una lámpara.



Es el tiempo durante el cual la bombilla funciona sin perder rendimiento luminoso.



Indica con qué ángulo se distribuye el haz de luz y por lo tanto, define el área que puede iluminar en función de la distancia a la fuente de luz.

Índice de protección IP

PRIMER DIGITO (Protección contra objetos sólidos)	DEFINICIÓN	SEGUNDO DIGITO (Protección contra líquidos)	DEFINICIÓN
0	SIN PROTECCIÓN	0	SIN PROTECCIÓN
1	Protegida contra objetos sólidos de más de 50 mm	1	Gotas de agua que caigan verticalmente.
2	Protegida contra objetos sólidos de más de 12 mm	2	Rocío directo hasta 15°.
3	Protegida contra objetos sólidos de más de 2.5 mm.	3	Rocío directo hasta 60°.
4	Protegida contra objetos sólidos de más de 1 mm.	4	Rocíos directos de todas las direcciones.
5	Protegida contra ingreso limitado de polvo.	5	Chorro de agua a baja presión de todas las direcciones.
6	Totalmente protegido contra polvo, totalmente sellado.	6	Fuertes chorros de agua de todas las direcciones.
		7	Inmersión temporal en agua a profundidades hasta 15cm.
		8	Largos periodos de inmersión bajo presión.

+13 años dedicados a iluminar tu vida

Estamos comprometidos a ofrecer productos lumínicos de vanguardia que ayuden a transformar espacios en ambientes de bienestar y confort.

Interiores

Línea focos

- 07 Foco led tipo bombilla
- 08 Foco led smart
- 09 Foco led vintage
- 10 Foco ahorrador espiral
- 11 Foco led tipo T
- 13 Foco led tipo T alta potencia

Línea paneles

- 15 Downlight led slim
- 16 Downlight ajustable
- 17 Downlight con driver integrado
- 26 Panel de sobreponer jwj
- 27 Downlight led slim jwj
- 28 Lámpara led ceiling
- 29 Panel led
- 33 Marco luminoso

Línea tubos led

- 35 Lámpara led tipo regleta
- 36 Tubo led con driver integrado
- 37 Tubo led T8 base G13
- 39 Gabinete para tubo led

Línea regletas led

- 41 Regleta led slim
- 42 Lámpara led tipo regleta
- 43 Lámpara interconectable

Línea dirigibles

- 45 Spot dirigible led
- 46 Accesorios para dirigibles
- 47 Spot dirigible lineal

Línea perfiles

- 49 Perfiles de aluminio para led

Línea tiras y mangueras

- 57 Tira led para perfil
- 58 Fuente de alimentación
- 59 Tira led 5 metros
- 70 Módulo led

Línea ventiladores

- 73 Ventiladores de techo
- 86 Ventiladores de pedestal
- 88 Ventilador de pared
- 89 Ventilador de torre

Línea lámparas de techo

- 91 Lámpara de techo
- 103 Lámpara colgante

Línea arbotantes de pared

- 107 Arbotante de pared
- 119 Arbotante lineal

Línea lámparas ufo

- 141 Luminario high bay

Línea emergencia

- 162 Lámparas de emergencia

Línea arbotantes de pared

- 107 Multicontactos y extensiones
- 119 Tomacorrientes

Exteriores

Línea tiras y mangueras

- 60 Manguera led 25 / 50metros
- 69 Tira led neón 5 metros

Línea reflectores

- 121 Reflector led COB alta potencia
- 122 Reflector led para estadios
- 124 Reflector led tipo lupa
- 127 Reflector multicolor

Línea solar

- 129 Panel solar con tubo solar
- 130 Reflector led con panel solar
- 132 Luminaria pública all in one

Línea luminarias públicas

- 135 Luminaria pública con fotocelda
- 138 Luminaria pública con base ajustable

Línea empotrados de piso

- 145 Lámpara de piso con estaca
- 146 Lámpara de piso empotrable
- 148 Lámpara de piso sobreponer
- 149 Lámpara led cañón de luz

Línea sumergible

- 151 Lámpara sumergible

Línea emergencia

- 161 Reflector de emergencia

Emerge lux

- 166 Lámparas de emergencia

Sucursales

- 182 Ubicación de Tiendas

TODA LA INFORMACIÓN EN UN SOLO LUGAR



Identifica el código QR



Escanea el código QR



Accede a toda la información

Línea Focos

JLA4

Foco led tipo bombilla



ESCANEA
ficha técnica



JLA4-6

Potencia	6W
Tono de Luz	6500 K Luz Fria — 2700 K Luz Cálida
Flujo Luminoso	480 lm
Tensión	127V~60Hz
Corriente Eléctrica	89mA
Dimensiones	(A) Ø55mm • (B) 105mm



JLA4-9

Potencia	9W
Tono de Luz	6500 K Luz Fria — 2700 K Luz Cálida
Flujo Luminoso	668 lm
Tensión	127V~60Hz
Corriente Eléctrica	130mA
Dimensiones	(A) Ø60mm • (B) 113mm



JLA4-12

Potencia	12W
Tono de Luz	6500 K Luz Fria — 2700 K Luz Cálida
Flujo Luminoso	1 100 lm
Tensión	127V~60Hz
Corriente Eléctrica	158mA
Dimensiones	(A) Ø60mm • (B) 115mm



JLA4-15

Potencia	15W
Tono de Luz	6500 K Luz Fria — 2700 K Luz Cálida
Flujo Luminoso	1 200 lm
Tensión	127V~60Hz
Corriente Eléctrica	208mA
Dimensiones	(A) Ø68mm • (B) 138mm



JLA4-18

Potencia	18W
Tono de Luz	6500 K Luz Fria — 2700 K Luz Cálida
Flujo Luminoso	1 600 lm
Tensión	127V~60Hz
Corriente Eléctrica	257mA
Dimensiones	(A) Ø80mm • (B) 155mm

Dimensiones

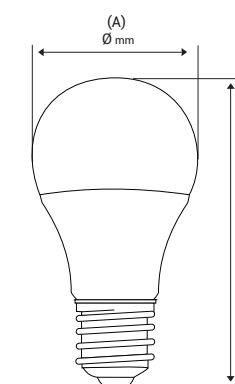

Interiores

JLA4-10

Foco led SMART



ESCANEA
ficha técnica



- Temporizador
- Conexión WiFi
- Modo música



JLA4-10

Potencia	10W
Tono de Luz	6500 K Luz Fria 4000 K Luz Neutra 2700 K Luz Calida
Flujo Luminoso	>850lm
Tensión	127V~60Hz
Corriente Eléctrica	85mA
Dimensiones	(A) Ø57mm • (B) 114mm

Dimensiones

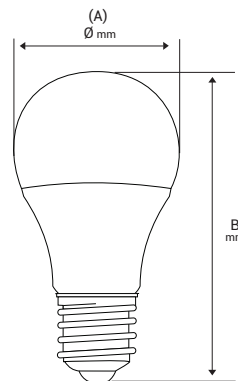

Interiores

JLA5-4 JLA6-4

Foco led vintage



ESCANEA
ficha técnica



JLA5-4

Potencia	4W
Tono de Luz	2700 K Luz Calida
Flujo Luminoso	500 lm
Tensión	110V~50/60Hz
Corriente Eléctrica	38 mA
Dimensiones	(A) Ø65mm • (B) 150mm



ESCANEA
ficha técnica



JLA6-4

Potencia	4W
Tono de Luz	2700 K Luz Calida
Flujo Luminoso	500 lm
Tensión	110V~50/60Hz
Corriente Eléctrica	38mA
Dimensiones	(A) Ø95mm • (B) 137mm

Dimensiones

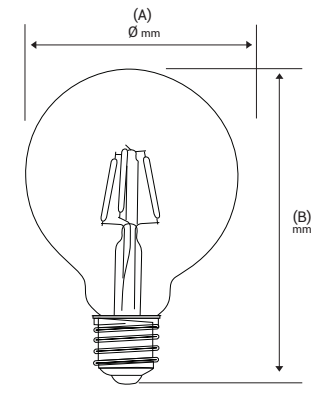
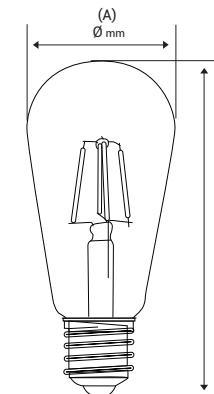

JBL

Foco ahorrador espiral



ESCANEA
ficha técnica



JBL-613

Potencia	13W
Tono de Luz	6500 K Luz Fria
Flujo Luminoso	715 lm
Tensión	127V~60Hz
Corriente Eléctrica	165mA
Dimensiones	(A) Ø46mm • (B) 135mm



JBL-625

Potencia	25W
Tono de Luz	6500 K Luz Fria
Flujo Luminoso	1 500 lm
Tensión	127V~60Hz
Corriente Eléctrica	350mA
Dimensiones	(A) Ø60mm • (B)160mm



JBL-630

Potencia	30W
Tono de Luz	6500 K Luz Fria
Flujo Luminoso	1 800 lm
Tensión	127V~60Hz
Corriente Eléctrica	430mA
Dimensiones	(A) Ø60mm • (B) 170mm



JBL-635

Potencia	35W
Tono de Luz	6500 K Luz Fria
Flujo Luminoso	2 100 lm
Tensión	127V~60Hz
Corriente Eléctrica	500mA
Dimensiones	(A) Ø60mm • (B) 175mm



JBL-665

Potencia	65W
Tono de Luz	6500 K Luz Fria
Flujo Luminoso	3 900 lm
Tensión	127V~60Hz
Corriente Eléctrica	930mA
Dimensiones	(A) Ø80mm • (B)255mm

Dimensiones

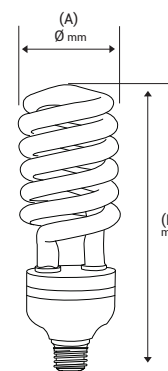

JLT

Foco led tipo T



ESCANEA
ficha técnica



JLT-9

Potencia	9W
Tono de Luz	6500 K Luz Fria / 2700 K Luz Calida
Flujo Luminoso	668 lm
Tensión	127V~60Hz
Corriente Eléctrica	130mA
Dimensiones	(A) Ø33mm • (B) 120mm



JLT-15

Potencia	15W
Tono de Luz	6500 K Luz Fria / 2700 K Luz Calida
Flujo Luminoso	1 200 lm
Tensión	127V~60Hz
Corriente Eléctrica	208mA
Dimensiones	(A) Ø42mm • (B)140mm



JLT-30

Potencia	30W
Tono de Luz	6500 K Luz Fria
Flujo Luminoso	2 400 lm
Tensión	110-240V~50/60Hz
Corriente Eléctrica	390mA
Dimensiones	(A) Ø100mm • (B) 154mm



JLT-40

Potencia	40W
Tono de Luz	6500 K Luz Fria
Flujo Luminoso	3 200 lm
Tensión	110-240V~50/60Hz
Corriente Eléctrica	520mA
Dimensiones	(A) Ø117mm • (B) 170mm



JLT-48

Potencia	48W
Tono de Luz	6500 K Luz Fria
Flujo Luminoso	3 800 lm
Tensión	110-240V~50/60Hz
Corriente Eléctrica	650mA
Dimensiones	(A) Ø138mm • (B)195mm

Dimensiones

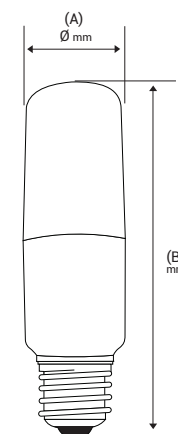

JLT

Foco led tipo T alta potencia



ESCANEAR
ficha técnica



JLT-50

Potencia	50W
Tono de Luz	6500 K Luz Fria
Flujo Luminoso	4 500 lm
Tensión	100-240V~50/60Hz
Corriente Eléctrica	460 mA máx.
Dimensiones	(A) Ø104mm • (B) 200mm



JLT-100

Potencia	100W
Tono de Luz	6500 K Luz Fria
Flujo Luminoso	9 000 lm
Tensión	100-240V~50/60Hz
Corriente Eléctrica	900mA máx.
Dimensiones	(A) Ø145mm • (B) 255mm

Dimensiones

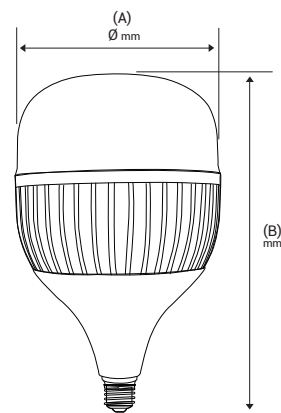

JLRE27-R

Foco led tipo plafón



ESCANEAR
ficha técnica



JLE27-R18

Potencia	18W
Tono de Luz	6500 K Luz Fria
Flujo Luminoso	1 600 lm
Tensión	100-240V~50/60Hz
Corriente Eléctrica	150mA
Dimensiones	(A) Ø200mm • (B) 70mm



JLE27-R28

Potencia	28W
Tono de Luz	6500 K Luz Fria
Flujo Luminoso	2 600 lm
Tensión	100-240V~50/60Hz
Corriente Eléctrica	250mA
Dimensiones	(A) Ø235mm • (B) 70mm



JLE27-R38

Potencia	38W
Tono de Luz	6500 K Luz Fria
Flujo Luminoso	3 300 lm
Tensión	100-240V~50/60Hz
Corriente Eléctrica	330mA
Dimensiones	(A) Ø270mm • (B) 70mm

Dimensiones

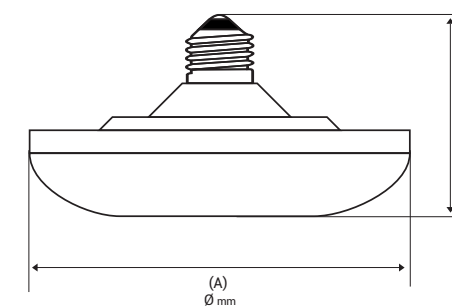



Línea Paneles

JLPC / JLPR

Downlight led slim



ESCANEA
ficha técnica

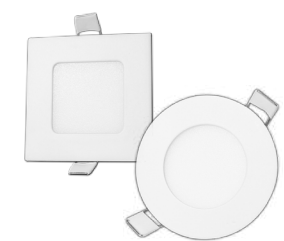

JLPC-3 / JLPR-3

Potencia	3W
Tono de Luz	6500 K Luz Fria - 2700 K Luz Calida
Flujo Luminoso	230 lm
Tensión	127V~60Hz
Corriente Eléctrica	23mA
Dimensiones	(A) 85mm • (B) 10mm • (C) 75mm

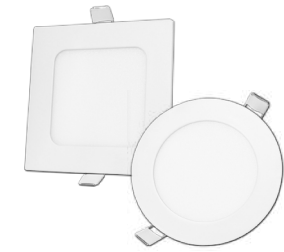

JLPC-6 / JLPR-6

Potencia	6W
Tono de Luz	6500 K Luz Fria - 2700 K Luz Calida
Flujo Luminoso	450 lm
Tensión	127V~60Hz
Corriente Eléctrica	45mA
Dimensiones	(A) 120mm • (B) 10mm • (C) 110mm



JLPC-9 / JLPR-9

Potencia	9W
Tono de Luz	6500 K Luz Fria - 2700 K Luz Calida
Flujo Luminoso	700 lm
Tensión	127V~60Hz
Corriente Eléctrica	70mA
Dimensiones	(A) 150mm • (B) 10mm • (C) 135mm



JLPC-12 / JLPR-12

Potencia	12W
Tono de Luz	6500 K Luz Fria - 2700 K Luz Calida
Flujo Luminoso	950 lm
Tensión	127V~60Hz
Corriente Eléctrica	95mA
Dimensiones	(A) 170mm • (B) 10mm • (C) 155mm

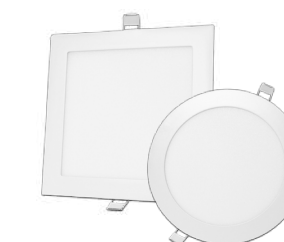

JLPC-15 / JLPR-15

Potencia	15W
Tono de Luz	6500 K Luz Fria - 2700 K Luz Calida
Flujo Luminoso	1 200 lm
Tensión	127V~60Hz
Corriente Eléctrica	115mA
Dimensiones	(A) 190mm • (B) 10mm • (C) 175mm



JLPC-18 / JLPR-18

Potencia	18W
Tono de Luz	6500 K Luz Fria - 2700 K Luz Calida
Flujo Luminoso	1 400 lm
Tensión	127V~60Hz
Corriente Eléctrica	140mA
Dimensiones	(A) 220mm • (B) 10mm • (C) 205mm



JLPC-24 / JLPR-24

Potencia	24W
Tono de Luz	6500 K Luz Fria - 2700 K Luz Calida
Flujo Luminoso	2 160 lm
Tensión	127V~60Hz
Corriente Eléctrica	189mA
Dimensiones	(A) 300mm • (B) 10mm • (C) 273mm

Dimensiones

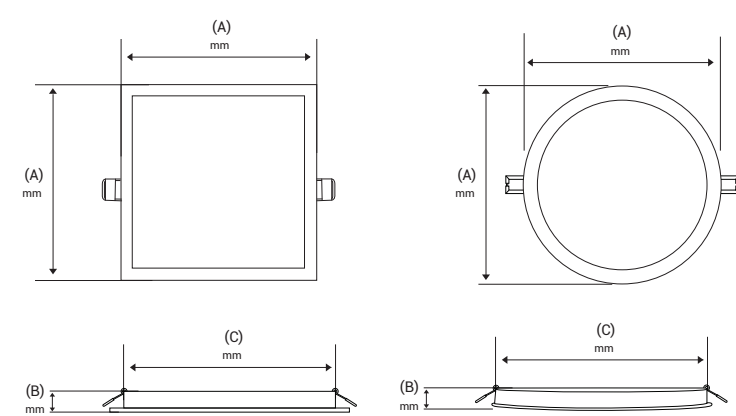

JLPR-A JLPC-A

Downlight ajustable



ESCANEA
ficha técnica



JLPR-6A / JLPC-6A

Potencia	6W
Tono de Luz	6500 K Luz Fria - 2700 K Luz Calida
Flujo Luminoso	540 lm
Tensión	127V~60Hz
Corriente Eléctrica	45mA
Dimensiones	(A) 100mm • (B) 25mm (C) Ajustable 40mm-65mm



JLPR-9A / JLPC-9A

Potencia	9W
Tono de Luz	6500 K Luz Fria - 2700 K Luz Calida
Flujo Luminoso	810 lm
Tensión	127V~60Hz
Corriente Eléctrica	70mA
Dimensiones	(A) 115mm • (B) 25mm (C) Ajustable 40mm-80mm



JLPR-15A / JLPC-15A

Potencia	15W
Tono de Luz	6500 K Luz Fria - 2700 K Luz Calida
Flujo Luminoso	1 350 lm
Tensión	127V~60Hz
Corriente Eléctrica	115mA
Dimensiones	(A) 170mm • (B) 25mm (C) Ajustable 40mm-125mm



JLPR-20A / JLPC-20A

Potencia	20W
Tono de Luz	6500 K Luz Fria - 2700 K Luz Calida
Flujo Luminoso	1 800 lm
Tensión	127V~60Hz
Corriente Eléctrica	157mA
Dimensiones	(A) 230mm • (B) 25mm (C) Ajustable 40mm-180mm

Dimensiones

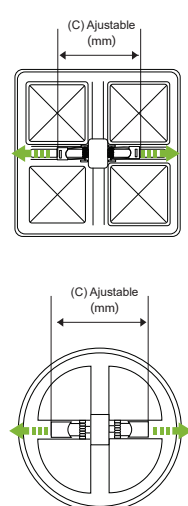
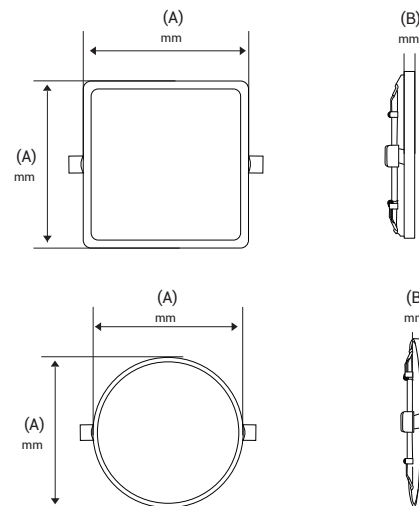

JLTR-A

Downlight con driver integrado



ESCANEA
ficha técnica



JLTR-5A

Potencia	5W
Tono de Luz	6500 K Luz Fria - 4000 K Luz Neutra
Flujo Luminoso	425 lm
Tensión	127V~60Hz
Corriente Eléctrica	39mA
Bote Integral	6
Dimensiones	(A) Ø98mm • (B) 35mm • (C) Ø65mm



JLTR-9A

Potencia	9W
Tono de Luz	6500 K Luz Fria - 4000 K Luz Neutra
Flujo Luminoso	700 lm
Tensión	127V~60Hz
Corriente Eléctrica	70mA
Bote Integral	8
Dimensiones	(A) Ø120mm • (B) 40mm • (C) Ø90mm



JLTR-12A

Potencia	12W
Tono de Luz	6500 K Luz Fria - 4000 K Luz Neutra
Flujo Luminoso	950 lm
Tensión	127V~60Hz
Corriente Eléctrica	95mA
Bote Integral	12
Dimensiones	(A) Ø140mm • (B) 45mm • (C) Ø95mm



JLTR-18A

Potencia	18W
Tono de Luz	6500 K Luz Fria - 4000 K Luz Neutra
Flujo Luminoso	1 400 lm
Tensión	127V~60Hz
Corriente Eléctrica	140mA
Bote Integral	-
Dimensiones	(A) Ø175mm • (B) 55mm • (C) Ø130mm

Dimensiones

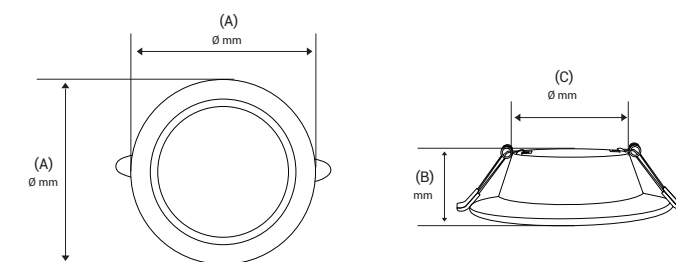

JLTR

Downlight con driver integrado



ESCANEA
ficha técnica



JLTR-5

Potencia	5W
Tono de Luz	6500 K Luz Fria - 4000 K Luz Neutra
Flujo Luminoso	425 lm
Tensión	127V~60Hz
Corriente Eléctrica	39mA
Dimensiones	(A) Ø100mm • (B) 60mm • (C) Ø70mm



JLTR-9

Potencia	9W
Tono de Luz	6500 K Luz Fria - 4000 K Luz Neutra
Flujo Luminoso	700 lm
Tensión	127V~60Hz
Corriente Eléctrica	70mA
Dimensiones	(A) Ø120mm • (B) 60mm • (C) Ø80mm



JLTR-12

Potencia	12W
Tono de Luz	6500 K Luz Fria - 4000 K Luz Neutra
Flujo Luminoso	950 lm
Tensión	127V~60Hz
Corriente Eléctrica	95mA
Dimensiones	(A) Ø140mm • (B) 70mm • (C) Ø100mm



JLTR-18

Potencia	18W
Tono de Luz	6500 K Luz Fria - 4000 K Luz Neutra
Flujo Luminoso	1 400 lm
Tensión	127V~60Hz
Corriente Eléctrica	140mA
Dimensiones	(A) Ø175mm • (B) 80mm • (C) Ø120mm

Dimensiones

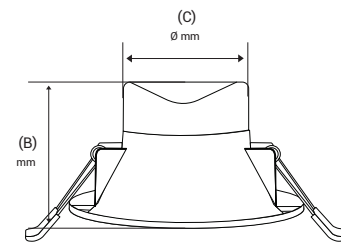
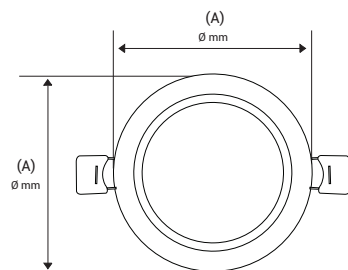

JLPR-DI

Downlight con driver integrado



ESCANEA
ficha técnica



JLPR-6DI

Potencia	6W
Tono de Luz	6500 K Luz Fria - 2700 K Luz Calida
Flujo Luminoso	350 lm
Tensión	100-240V~50/60Hz
Corriente Eléctrica	45mA
Dimensiones	(A) Ø102mm • (B) Ø61mm • (C) 25mm



JLPR-9DI

Potencia	9W
Tono de Luz	6500 K Luz Fria - 2700 K Luz Calida
Flujo Luminoso	750 lm
Tensión	100-240V~50/60Hz
Corriente Eléctrica	70mA
Dimensiones	(A) Ø120mm • (B) Ø80mm • (C) 25mm



JLPR-12DI

Potencia	12W
Tono de Luz	6500 K Luz Fria - 2700 K Luz Calida
Flujo Luminoso	1 000 lm
Tensión	100-240V~50/60Hz
Corriente Eléctrica	133mA
Dimensiones	(A) Ø170mm • (B) Ø120mm • (C) 25mm



JLPR-18DI

Potencia	18W
Tono de Luz	6500 K Luz Fria - 2700 K Luz Calida
Flujo Luminoso	1 500 lm
Tensión	100-240V~50/60Hz
Corriente Eléctrica	140mA
Dimensiones	(A) Ø222mm • (B) Ø132mm • (C) 25mm



JLPR-24DI

Potencia	24W
Tono de Luz	6500 K Luz Fria - 2700 K Luz Calida
Flujo Luminoso	1 900 lm
Tensión	110-240V~50/60Hz
Corriente Eléctrica	189mA
Dimensiones	(A) Ø200mm • (B) Ø162mm • (C) 25mm

Dimensiones

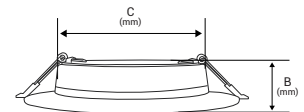
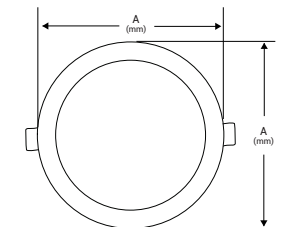

JLPR-DIS

Downlight con driver integrado

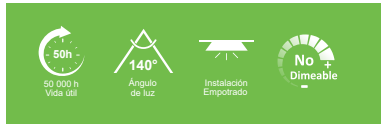

ESCANEA
ficha técnica



JLPR-9DIS

Potencia	9W
Tono de Luz	6500 K Luz Fria
Flujo Luminoso	750 lm
Tensión	100-240V~50/60Hz
Corriente Eléctrica	70mA
Dimensiones	(A) Ø117mm • (B) 25mm • (C) Ø80



JLPR-12DIS

Potencia	12W
Tono de Luz	6500 K Luz Fria
Flujo Luminoso	1 000 lm
Tensión	100-240V~50/60Hz
Corriente Eléctrica	133mA
Dimensiones	(A) Ø145mm • (B) 30mm • (C) Ø100

Dimensiones

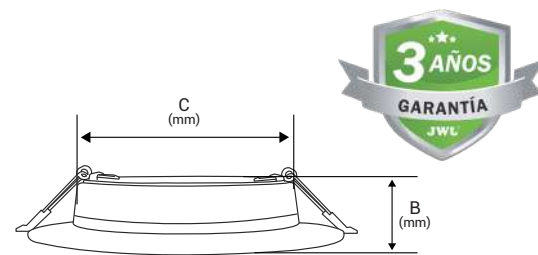
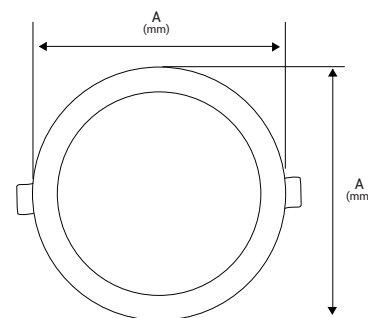

JLP

Downlight dirigible



ESCANEA
ficha técnica



JLP-3X1

Potencia	3W
Tono de Luz	6500 K Luz Fria
Flujo Luminoso	255 lm
Tensión	127V~60Hz
Corriente Eléctrica	21mA
Dimensiones	(A) Ø85mm • (B) 45mm • (C) Ø70mm



JLP-5X1

Potencia	5W
Tono de Luz	6500 K Luz Fria
Flujo Luminoso	425 lm
Tensión	127V~60Hz
Corriente Eléctrica	39mA
Dimensiones	(A) Ø107mm • (B) 62mm • (C) Ø90mm



JLP-7X1

Potencia	7W
Tono de Luz	6500 K Luz Fria
Flujo Luminoso	595 lm
Tensión	127V~60Hz
Corriente Eléctrica	98mA
Dimensiones	(A) Ø109mm • (B) 65mm • (C) Ø92mm



JLP-12X1

Potencia	12W
Tono de Luz	6500 K Luz Fria
Flujo Luminoso	1 020 lm
Tensión	127V~60Hz
Corriente Eléctrica	133mA
Dimensiones	(A) Ø138mm • (B) 62mm • (C) Ø116mm

Dimensiones

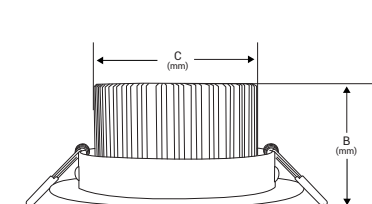
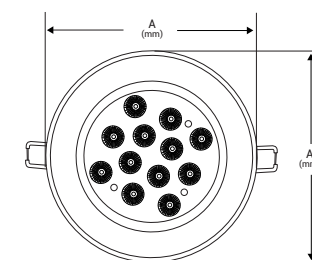

JLP

Downlight dirigible



ESCANEAR
ficha técnica



JLP-9

Potencia	9W
Tono de Luz	6500 K Luz Fria - 2700 K Luz Calida
Flujo Luminoso	810 lm
Tensión	127V~60Hz
Corriente Eléctrica	71 mA
Dimensiones	(A) Ø98mm • (B) 35mm • (C) Ø65mm



JLP-12

Potencia	12W
Tono de Luz	6500 K Luz Fria - 2700 K Luz Calida
Flujo Luminoso	1080 lm
Tensión	127V~60Hz
Corriente Eléctrica	94mA
Dimensiones	(A) Ø100mm • (B) 99mm • (C) Ø60mm



JLP-18

Potencia	18W
Tono de Luz	6500 K Luz Fria - 2700 K Luz Calida
Flujo Luminoso	1620 lm
Tensión	127V~60Hz
Corriente Eléctrica	142mA
Dimensiones	(A) Ø114mm • (B) 104mm • (C) Ø77mm

Dimensiones

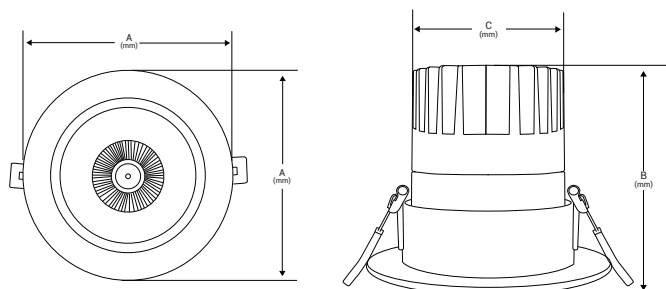

JLB

Downlight dirigible



ESCANEAR
ficha técnica



JLB-6

Potencia	6W
Tono de Luz	6500 K Luz Fria
Flujo Luminoso	450 lm
Tensión	110-240V~50/60Hz
Corriente Eléctrica	45mA
Dimensiones	(A) Ø90mm • (B) 40mm • (C) Ø50mm



JLB-9

Potencia	9W
Tono de Luz	6500 K Luz Fria
Flujo Luminoso	660 lm
Tensión	110-240V~50/60Hz
Corriente Eléctrica	70mA
Dimensiones	(A) Ø110mm • (B) 40mm • (C) Ø65mm



JLB-12

Potencia	12W
Tono de Luz	6500 K Luz Fria
Flujo Luminoso	870 lm
Tensión	110-240V~50/60Hz
Corriente Eléctrica	95mA
Dimensiones	(A) Ø140mm • (B) 40mm • (C) Ø80mm



JLB-18

Potencia	18W
Tono de Luz	6500 K Luz Fria
Flujo Luminoso	1 290 lm
Tensión	110-240V~50/60Hz
Corriente Eléctrica	140mA
Dimensiones	(A) Ø160mm • (B) 40mm • (C) Ø80mm

Dimensiones

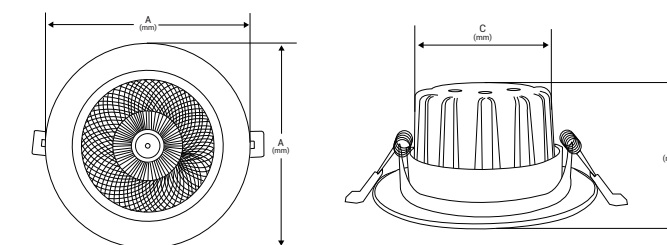

JLSR JLSR-N

Panel de sobreponer



ESCANEA
ficha técnica



JLSR-6 / JLSR-6N

Potencia	6W
Tono de Luz	6500 K Luz Fria - 2700 K Luz Calida
Flujo Luminoso	450 lm
Tensión	127V~60Hz
Corriente Eléctrica	45mA
Dimensiones	(A) 120mm • (B) 35mm



JLSR-12 / JLSR-12N

Potencia	12W
Tono de Luz	6500 K Luz Fria - 2700 K Luz Calida
Flujo Luminoso	950 lm
Tensión	127V~60Hz
Corriente Eléctrica	95mA
Dimensiones	(A) 170mm • (B) 35mm

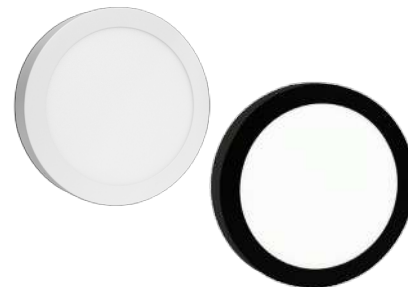

JLSR-18 / JLSR-18N

Potencia	18W
Tono de Luz	6500 K Luz Fria - 2700 K Luz Calida
Flujo Luminoso	1 400 lm
Tensión	127V~60Hz
Corriente Eléctrica	140mA
Dimensiones	(A) 220mm • (B) 35mm



JLSR-24 / JLSR-24N

Potencia	24W
Tono de Luz	6500 K Luz Fria - 2700 K Luz Calida
Flujo Luminoso	1 800 lm
Tensión	127V~60Hz
Corriente Eléctrica	189mA
Dimensiones	(A) 300mm • (B) 35mm

Dimensiones

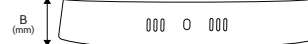
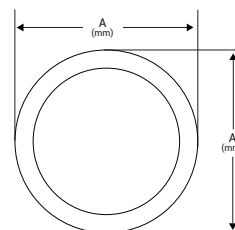

JLSC JLSC-N

Panel de sobreponer



ESCANEA
ficha técnica



JLSC-6 / JLSC-6N

Potencia	6W
Tono de Luz	6500 K Luz Fria - 2700 K Luz Calida
Flujo Luminoso	450 lm
Tensión	127V~60Hz
Corriente Eléctrica	45mA
Dimensiones	(A) 120mm • (B) 35mm



JLSC-12 / JLSC-12N

Potencia	12W
Tono de Luz	6500 K Luz Fria - 2700 K Luz Calida
Flujo Luminoso	950 lm
Tensión	127V~60Hz
Corriente Eléctrica	95mA
Dimensiones	(A) 170mm • (B) 35mm



JLSC-18 / JLSC-18N

Potencia	18W
Tono de Luz	6500 K Luz Fria - 2700 K Luz Calida
Flujo Luminoso	1 400 lm
Tensión	127V~60Hz
Corriente Eléctrica	140mA
Dimensiones	(A) 220mm • (B) 35mm



JLSC-24 / JLSC-24N

Potencia	24W
Tono de Luz	6500 K Luz Fria - 2700 K Luz Calida
Flujo Luminoso	1 800 lm
Tensión	127V~60Hz
Corriente Eléctrica	189mA
Dimensiones	(A) 300mm • (B) 35mm

Dimensiones

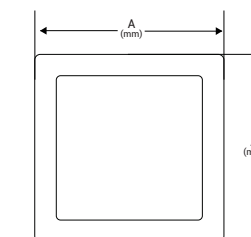

JUSR

Panel de sobreponer



ESCANEA
ficha técnica

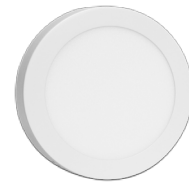

JUSR-6

Potencia	6W
Tono de Luz	6500 K Luz Fría
Flujo Luminoso	450 lm
Tensión	127V~60Hz
Corriente Eléctrica	45mA
Dimensiones	(A) 107mm • (B) 28mm

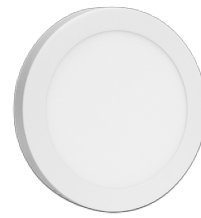

JUSR-12

Potencia	12W
Tono de Luz	6500 K Luz Fría
Flujo Luminoso	950 lm
Tensión	127V~60Hz
Corriente Eléctrica	95mA
Dimensiones	(A) 155mm • (B) 28mm



JUSR-18

Potencia	18W
Tono de Luz	6500 K Luz Fría
Flujo Luminoso	1 400 lm
Tensión	127V~60Hz
Corriente Eléctrica	140mA
Dimensiones	(A) 205mm • (B) 28mm



JUSR-24

Potencia	24W
Tono de Luz	6500 K Luz Fría
Flujo Luminoso	1 8000 lm
Tensión	127V~60Hz
Corriente Eléctrica	189mA
Dimensiones	(A) 280mm • (B) 28mm

Dimensiones

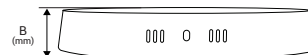
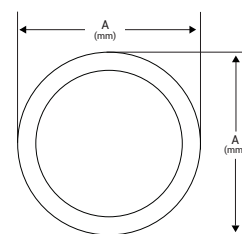

JUPR

Downlight led slim



ESCANEA
ficha técnica



JUPR-6

Potencia	6W
Tono de Luz	6500 K Luz Fría
Flujo Luminoso	450 lm
Tensión	127V~60Hz
Corriente Eléctrica	45mA
Dimensiones	(A) 120mm • (B) 10mm (C) 95mm



JUPR-9

Potencia	9W
Tono de Luz	6500 K Luz Fría
Flujo Luminoso	700 lm
Tensión	127V~60Hz
Corriente Eléctrica	70mA
Dimensiones	(A) 140mm • (B) 10mm (C) 120mm



JUPR-12

Potencia	12W
Tono de Luz	6500 K Luz Fría
Flujo Luminoso	950 lm
Tensión	127V~60Hz
Corriente Eléctrica	95mA
Dimensiones	(A) 165mm • (B) 10mm (C) 145mm



JUPR-18

Potencia	18W
Tono de Luz	6500 K Luz Fría
Flujo Luminoso	1 400 lm
Tensión	127V~60Hz
Corriente Eléctrica	140mA
Dimensiones	(A) 220mm • (B) 10mm (C) 195mm



JUPR-24

Potencia	24W
Tono de Luz	6500 K Luz Fría
Flujo Luminoso	2 160 lm
Tensión	127V~60Hz
Corriente Eléctrica	189mA
Dimensiones	(A) 295mm • (B) 10mm (C) 270mm

Dimensiones

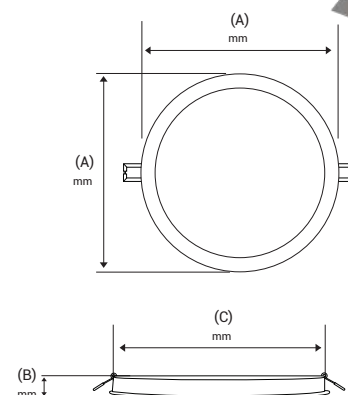

Interiores



JLCR

Lámpara led ceiling



ESCAÑEA
ficha técnica



JLCR-25

Potencia	25W
Tono de Luz	6500 K Luz Fria
Flujo Luminoso	2 250 lm
Tensión	127V~60Hz
Corriente Eléctrica	200mA
Dimensiones	(A) Ø292mm • (B) 53mm • (C) Ø245mm

JLCR-40

Potencia	40W
Tono de Luz	6500 K Luz Fria
Flujo Luminoso	3 600 lm
Tensión	127V~60Hz
Corriente Eléctrica	320mA
Dimensiones	(A) Ø360mm • (B) 57mm • (C) Ø320mm

JLCR-50

Potencia	50W
Tono de Luz	6500 K Luz Fria
Flujo Luminoso	4 500 lm
Tensión	127V~60Hz
Corriente Eléctrica	390mA
Dimensiones	(A) Ø458mm • (B) 67mm • (C) Ø394mm

Dimensiones

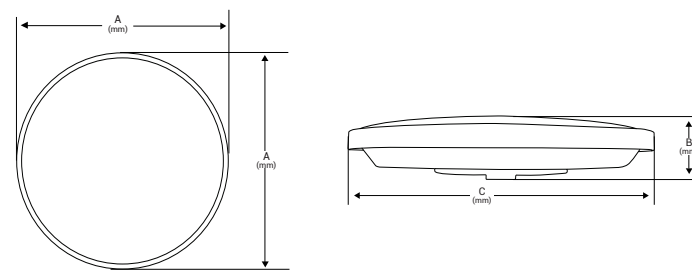

Interiores

JLBR

Panel led



ESCAÑEA
ficha técnica

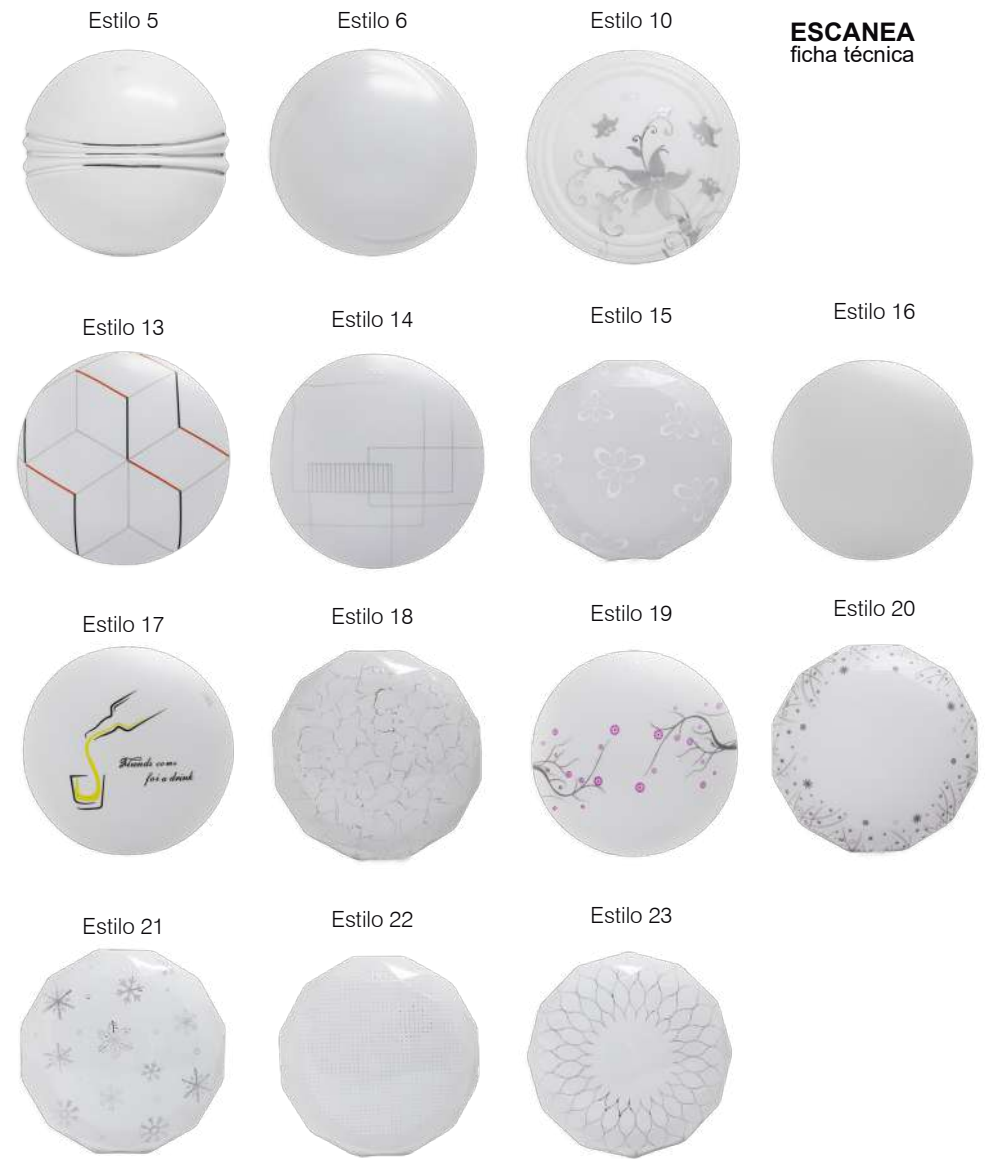

MODELO	POTENCIA	CORRIENTE ELÉCTRICA	LUMENES
JLBR-5	5W	40mA	425lm
JLBR-13	13W	100mA	1 105lm
JLBR-20	20W	157mA	1 700lm
JLBR-24	24W	189mA	2 040lm



JLPP-40X

Panel led



ESCANEA
ficha técnica



JLPP-40X

Potencia	40W
Tono de Luz	 6500 K Luz Fria 4000 K Luz Neutra 2700 K Luz Calida
Flujo Luminoso	4 200 lm
Tensión	127V~60Hz
Corriente Eléctrica	338mA
Dimensiones	(A) 595mm * (B) 595mm * (C) 29.5mm

Dimensiones

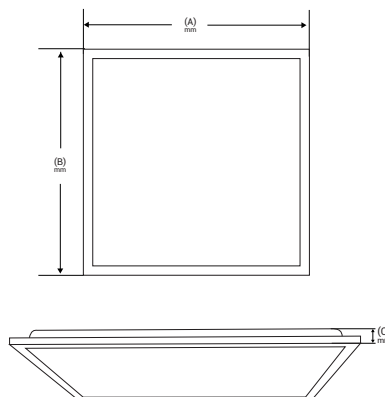

Accesorios

*No incluidos se vende por separado



KIT TENSORES
Para montaje suspendido
JLPP-40X / JLPP-40L



JLPP-40L

Panel led



ESCANEA
ficha técnica



JLPP-40L

Potencia	40W
Tono de Luz	 6500 K Luz Fria
Flujo Luminoso	4 200 lm
Tensión	127V~60Hz
Corriente Eléctrica	338mA
Dimensiones	(A) 1195mm * (B) 295mm * (C) 29.5mm

Dimensiones

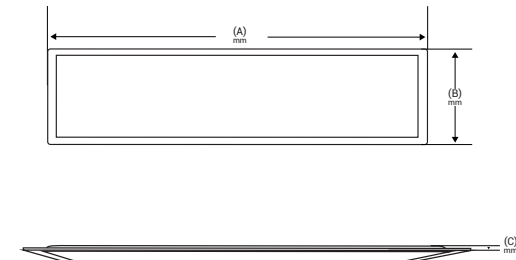

Accesorios

*No incluidos se vende por separado



KIT TENSORES
Para montaje suspendido
JLPP-40X / JLPP-40L



JLPP-M

Panel led



ESCANEA
ficha técnica

JLPP-22M

Potencia	22W
Tono de Luz	6500 K Luz Fria
Flujo Luminoso	1 980 lm
Tensión	127V~60Hz
Corriente Eléctrica	220mA
Dimensiones	(A) 1182mm • (B) 70mm • (C) 45mm

JLPP-42M

Potencia	42W
Tono de Luz	6500 K Luz Fria
Flujo Luminoso	3 780 lm
Tensión	127V~60Hz
Corriente Eléctrica	394mA
Dimensiones	(A) 1182mm • (B) 180mm • (C) 45mm

JLPP-62M

Potencia	62W
Tono de Luz	6500 K Luz Fria
Flujo Luminoso	5 580 lm
Tensión	127V~60Hz
Corriente Eléctrica	471mA
Dimensiones	(A) 1182mm • (B) 280mm • (C) 45mm

Dimensiones

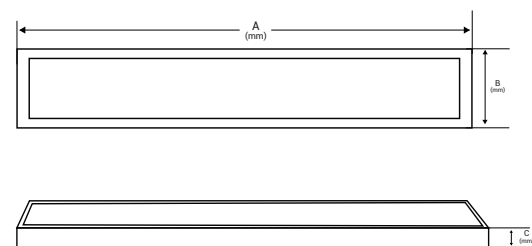

Accesorios

*No incluidos se vende por separado



PUENTE
Para montaje
sobreponer en techo.



TENSORES
Para montaje
suspendido

JLPP-40M

Marco luminoso



ESCANEA
ficha técnica



JLPP-40M

Potencia	40W
Tono de Luz	6500 K Luz Fria
Flujo Luminoso	3 000 lm
Tensión	127V~60Hz
Corriente Eléctrica	338mA
Dimensiones	(A) 595mm • (B) 595mm • (C) 29.5mm

Dimensiones

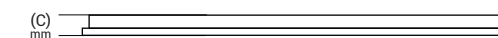
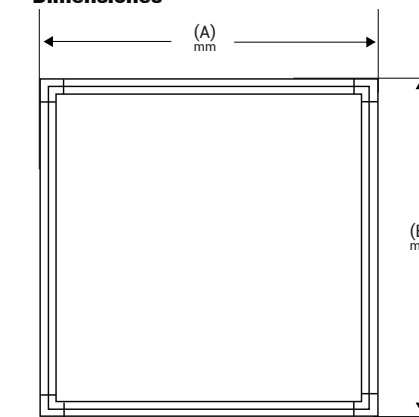



Línea Tubos LED

JLT5

Lámpara led tipo regleta



ESCANEA
ficha técnica



JLT5-91

Potencia	9W
Tono de Luz	6500 K Luz Fria
Flujo Luminoso	900 lm
Tensión	127V~60Hz
Corriente Eléctrica	100mA
Dimensiones	(A)527mm • (B)24mm • (C)24mm

Dimensiones

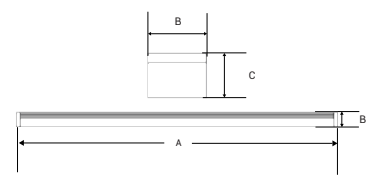

JLT5-181

Potencia	18W
Tono de Luz	6500 K Luz Fria
Flujo Luminoso	1 800 lm
Tensión	127V~60Hz
Corriente Eléctrica	215mA
Dimensiones	(A)1140mm • (B)24mm • (C)24mm

Dimensiones

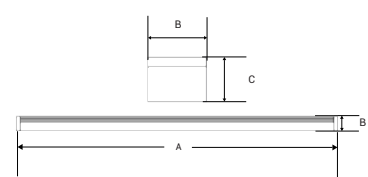

JLT5/JLT8

Tubo led con driver integrado



ESCANEA
ficha técnica



JLT5-95

Potencia	9W
Tono de Luz	6500 K Luz Fria / 2700 K Luz Calida
Flujo Luminoso	600 lm
Tensión	127V ~ 60Hz
Corriente Eléctrica	42mA
Dimensiones	(A) 670mm • (B) 33mm • (C) 22mm



JLT5-N9

Potencia	9W
Tono de Luz	6500 K Luz Fria / 2700 K Luz Calida
Flujo Luminoso	800 lm
Tensión	127V ~ 60Hz
Corriente Eléctrica	42mA
Dimensiones	(A) 650mm • (B) 33mm • (C) 24mm



JLT5-N18

Potencia	18W
Tono de Luz	6500 K Luz Fria / 2700 K Luz Calida
Flujo Luminoso	1 500 lm
Tensión	127V ~ 60Hz
Corriente Eléctrica	85-140mA
Dimensiones	(A) 1200 • (B) 33mm • (C) 24mm



JLT5-185

Potencia	18W
Tono de Luz	6500 K Luz Fria / 2700 K Luz Calida
Flujo Luminoso	1 400 lm
Tensión	127V ~ 60Hz
Corriente Eléctrica	85-19 0mA
Dimensiones	(A) 1175mm • (B) 33mm • (C) 24mm

Dimensiones

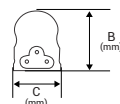
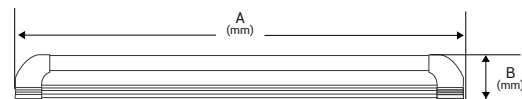

JLT8-N18

Potencia	18W
Tono de Luz	6500 K Luz Fria / 2700 K Luz Calida
Flujo Luminoso	1 500 lm
Tensión	127V ~ 60Hz
Corriente Eléctrica	85-190mA
Dimensiones	(A) 1200mm • (B) 33mm • (C) 31mm

JLT8

Tubo led T8 base G13



ESCANEA
ficha técnica



JLT8-92

Potencia	9W
Tono de Luz	6500 K Luz Fria / 2700 K Luz Calida
Flujo Luminoso	700 lm
Tensión	100-250V~60Hz
Corriente Eléctrica	42mA
Dimensiones	(A) 600mm • (B) 25.4mm



JLT8-167

Potencia	16W
Tono de Luz	6500 K Luz Fria / 2700 K Luz Calida
Flujo Luminoso	1 400 lm
Tensión	100-250V~60Hz
Corriente Eléctrica	170mA
Dimensiones	(A) 600mm • (B) 25.4mm



JLT8-182

Potencia	18W
Tono de Luz	6500 K Luz Fria / 2700 K Luz Calida
Flujo Luminoso	1 500 lm
Tensión	100-250V~60Hz
Corriente Eléctrica	85-190mA
Dimensiones	(A) 1 200mm • (B) 25.4mm



Dimensiones

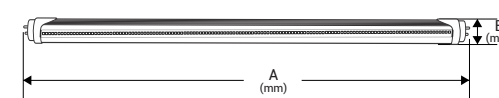

Accesorios

*No incluidos se vende por separado

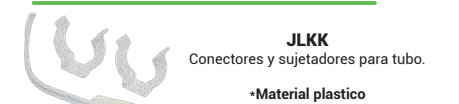

JLT8

Tubo led T8 base G13



ESCANEA
ficha técnica

JLT8-D18

Potencia	18W
Tono de Luz	6500 K Luz Fria — 2700 K Luz Calida
Flujo Luminoso	1 700 lm
Tensión	100-250V~60Hz
Corriente Eléctrica	85-190mA
Dimensiones	(A) 1 200mm • (B) 25.4mm



JLT8-327

Potencia	32W
Tono de Luz	6500 K Luz Fria — 2700 K Luz Calida
Flujo Luminoso	3 100 lm
Tensión	100-250V~60Hz
Corriente Eléctrica	280mA
Dimensiones	(A) 1 200mm • (B) 25.4mm



JUT8-186

Potencia	18W
Tono de Luz	6500 K Luz Fria — 2700 K Luz Calida
Flujo Luminoso	1 400 lm
Tensión	100-250V~60Hz
Corriente Eléctrica	85-190mA
Dimensiones	(A) 1 200mm • (B) 25.4mm



Dimensiones

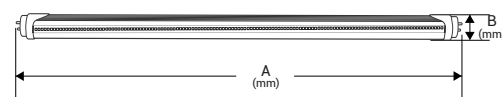

Accesorios

*No incluidos se vende por separado



JLKK
Conectores y sujetadores para tubo.

•Material plástico



Portalámpara Tubo T8
JBPA 1200mm
JBPB 600mm

•Material Aluminio

JCL-120

Gabinete para tubo led



ESCANEA
ficha técnica

JCL-120

Índice de protección	IP65
Socket	G-13
Dimensiones	(A) 1265 mm • (B) 105mm • (C) 50mm



Dimensiones

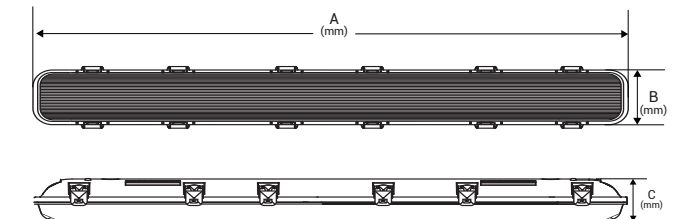



Línea Regletas LED

JLGS

Regleta led slim



ESCANEA
ficha técnica

JLGS-40

Potencia	40W
Tono de Luz	
Flujo Luminoso	2 800 lm
Tensión	110-240V~50/60Hz
Corriente Eléctrica	330 mA
Dimensiones	(A)1200mm • (B)76mm • (C)23mm



Dimensiones

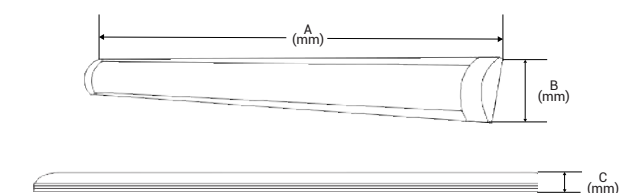

JLGS

Tubo led doble



JLGS-D36

Potencia	36W
Tono de Luz	6500 K Luz Fria
Flujo Luminoso	3 600 lm
Tensión	100-240V~50/60Hz
Corriente Eléctrica	283mA
Dimensiones	(A)1175mm • (B)73mm • (C)31mm

JLGS

Tubo led base FA8



JLGS-L36

Potencia	36W
Tono de Luz	6500 K Luz Fria
Flujo Luminoso	3 600 lm
Tensión	100-240V~50/60Hz
Corriente Eléctrica	283mA
Dimensiones	(A) 2380mm
Base	FA8



ESCANEA
ficha técnica

Dimensiones

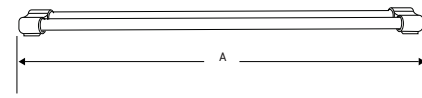
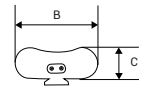

***IMPORTANTE**
Máximo 6 conexiones por línea.



ESCANEA
ficha técnica

Dimensiones

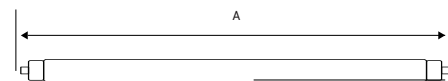

JLGS

Lámpara interconectable



JLGS-20V

Potencia	20W
Tono de Luz	6500 K Luz Fria
Flujo Luminoso	1 800 lm
Tensión	127V~60Hz
Corriente Eléctrica	157mA
Dimensiones	(A) 600 mm • (B) 53mm • (C) 42mm



JLGS-40V

Potencia	40W
Tono de Luz	6500 K Luz Fria
Flujo Luminoso	3 600 lm
Tensión	127V~60Hz
Corriente Eléctrica	330mA
Dimensiones	(A) 1200 mm • (B) 53mm • (C) 42mm

Dimensiones

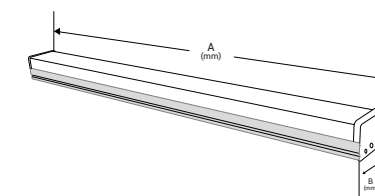

ESCANEA
ficha técnica

Accesorios

**No incluidos se vende por separado*

7 diferentes formas de coples

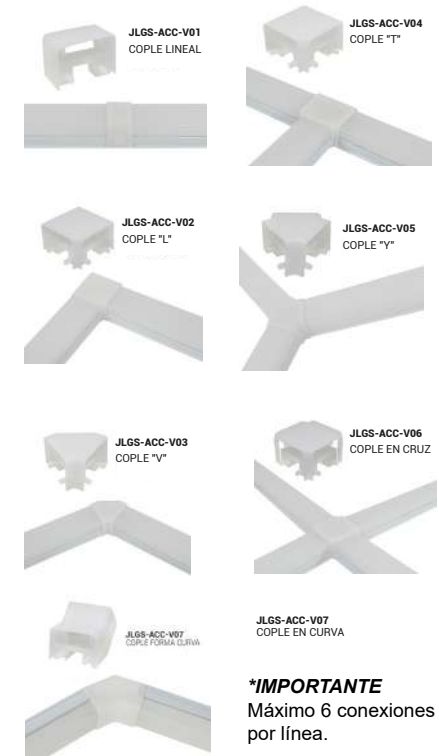

***IMPORTANTE**
Máximo 6 conexiones por línea.



JLGSACC09V
Tensores para montaje suspendido



JLGSACCV10
Tensores para montaje suspendido



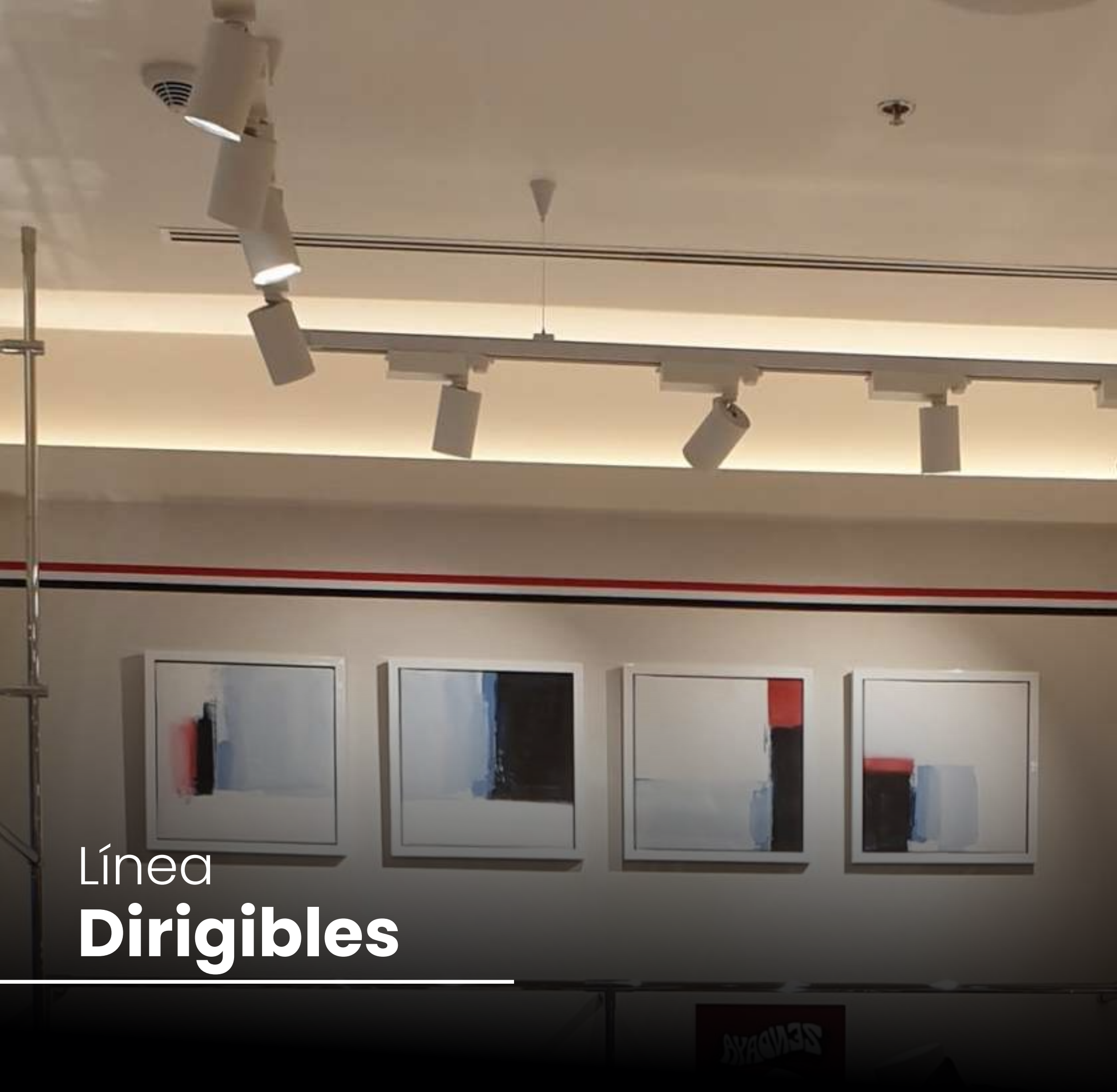

Línea Dirigibles

JLC

Spot dirigible led



ESCANEAR
ficha técnica



JLC-7

Potencia	7W
Tono de Luz	6500 K Luz Fria 4000 K Luz Neutra 2700 K Luz Calida
Flujo Luminoso	560 lm
Tensión	85-245V~50/60Hz
Corriente Eléctrica	90-100mA
Dimensiones	(A) 100mm • (B) 132mm • (C) 50mm • (D) 64mm • (E) 44mm • (F) 40mm



JLC-12

Potencia	12W
Tono de Luz	6500 K Luz Fria 4000 K Luz Neutra 2700 K Luz Calida
Flujo Luminoso	960 lm
Tensión	85-245V~50/60Hz
Corriente Eléctrica	240-250mA
Dimensiones	(A) 110mm • (B) 145mm • (C) 60mm • (D) 64mm • (E) 44mm • (F) 40mm



JLC-20

Potencia	20W
Tono de Luz	6500 K Luz Fria 4000 K Luz Neutra 2700 K Luz Calida
Flujo Luminoso	1 640 lm
Tensión	85-245V~50/60Hz
Corriente Eléctrica	260-270 mA
Dimensiones	(A) 160mm • (B) 145mm • (C) 65mm • (D) 85mm • (E) 44mm • (F) 40mm



JLC-30

Potencia	30W
Tono de Luz	6500 K Luz Fria 4000 K Luz Neutra 2700 K Luz Calida
Flujo Luminoso	2 400 lm
Tensión	85-245V~50/60Hz
Corriente Eléctrica	280-300 mA
Dimensiones	(A) 180mm • (B) 165mm • (C) 75mm • (D) 85mm • (E) 44mm • (F) 40mm

Dimensiones

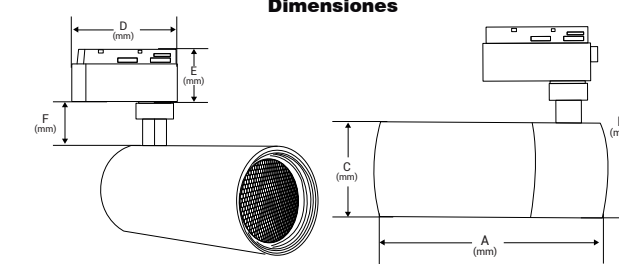

JLC-RIEL

Spot para riel

JLC-RIEL-1M

Acabado Blanco/Negro
Dimensiones (A) 1000mm • (B) 34mm • (C) 18mm



ESCANEA
ficha técnica

JLC-RIEL-1.5M

Acabado Blanco/Negro
Dimensiones (A) 1500mm • (B) 34mm • (C) 18mm

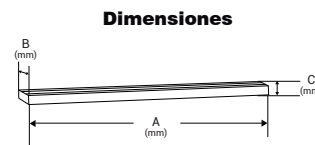

JLC-RIEL-2M

Acabado Blanco/Negro
Dimensiones (A) 2000mm • (B) 34mm • (C) 18mm



JLC-ACC-05

Base para instalación fija

JLC-ACC-05

Acabado Blanco/Negro
Dimensiones (A) 100mm • (B) 30mm • (C) 40mm

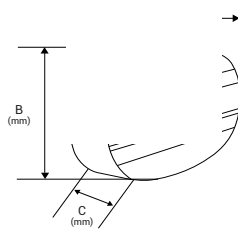

JLC-ACC

Conectores

JLC-ACC-01

Acabado Blanco/Negro

Conector lineal

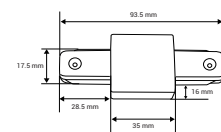

JLC-ACC-02

Acabado Blanco/Negro

Conector angular

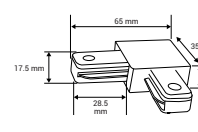

JLC-ACC-03

Acabado Blanco/Negro

Conector tipo T

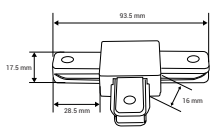

JLC-ACC-04

Acabado Blanco/Negro

Conector en cruz

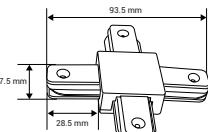

JLCA

Spot dirigible lineal



ESCANEA
ficha técnica



Dimensiones

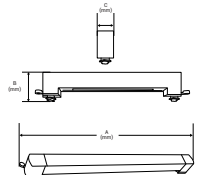

JLCA-10

Potencia	10W
Tono de Luz	6500 K Luz Fria / 2700 K Luz Cálida
Flujo Luminoso	900 lm
Tensión	85-265V~50/60Hz
Corriente Eléctrica	115mA
Dimensiones	(A) 300mm • (B) 60mm • (C) 35mm

JLCA-18

Potencia	18W
Tono de Luz	6500 K Luz Fria / 2700 K Luz Cálida
Flujo Luminoso	1 640 lm
Tensión	85-265V~50/60Hz
Corriente Eléctrica	210mA
Dimensiones	(A) 500mm • (B) 60mm • (C) 35mm

Las dimensiones varían según la potencia verifique la tabla de dimensiones por modelo.



ESCANEA
ficha técnica

JLCB

Spot dirigible lineal



Dimensiones

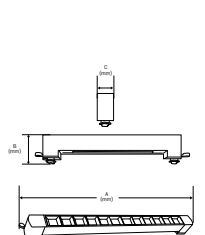

JLCB-12

Potencia	12W
Tono de Luz	6500 K Luz Fria / 2700 K Luz Cálida
Flujo Luminoso	1 380 lm
Tensión	85-265V~50/60Hz
Corriente Eléctrica	195mA
Dimensiones	(A) 300mm • (B) 60mm • (C) 35mm

JLCB-24

Potencia	24W
Tono de Luz	6500 K Luz Fria / 2700 K Luz Cálida
Flujo Luminoso	2 760 lm
Tensión	85-265V~50/60Hz
Corriente Eléctrica	300mA
Dimensiones	(A) 500mm • (B) 60mm • (C) 35mm

Las dimensiones varían según la potencia verifique la tabla de dimensiones por modelo.





Línea Perfiles

JAPF

Perfiles de aluminio para led



ESCANEA
ficha técnica



Incluye: kit de instalación
4 grapas y 4 tapas

Dimensiones

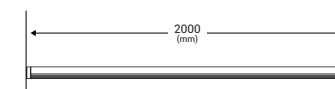
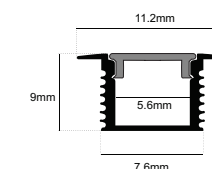

JAPF-0609A

Índice de Protección **IP20**

Tira recomendada JLTL-2835-05120

Material Aluminio anodizado



Incluye: kit de instalación
4 grapas y 4 tapas

Dimensiones

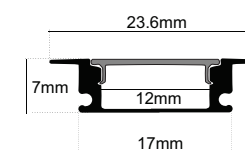

JAPF-1707A

Índice de Protección **IP20**

Tira recomendada JLTL-2835-08120
JLTL-2835-10240
JLTL-COB320

Material Aluminio anodizado

Accesorios

**No incluidos se vende por separado*



Fuente de alimentación
Disponible en
60W / 100W / 200W / 300W



Tira led para perfil
Disponible en
25W / 55W / 60W / 100W

JAPF

Perfiles de aluminio para led



ESCANEA
ficha técnica



Incluye: kit de instalación
4 grapas y 4 tapas

Dimensiones

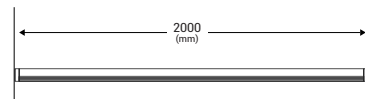
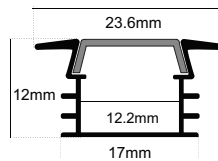

JAPF-1712A

Índice de Protección	IP20
Tira recomendada	JLTL-2835-08120 JLTL-2835-10240 JLTL-COB320
Material	Aluminio anodizado



Incluye: kit de instalación
4 grapas y 4 tapas

Dimensiones

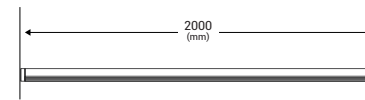
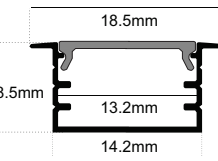

JAPF-1509A

Índice de Protección	IP20
Tira recomendada	JLTL-2835-10240
Material	Aluminio anodizado

Accesorios

**No incluidos se vende por separado*



Fuente de alimentación
Disponible en
60W / 100W / 200W / 300W



Tira led para perfil
Disponible en
25W / 55W / 60W / 100W

JAPF

Perfiles de aluminio para led



ESCANEA
ficha técnica

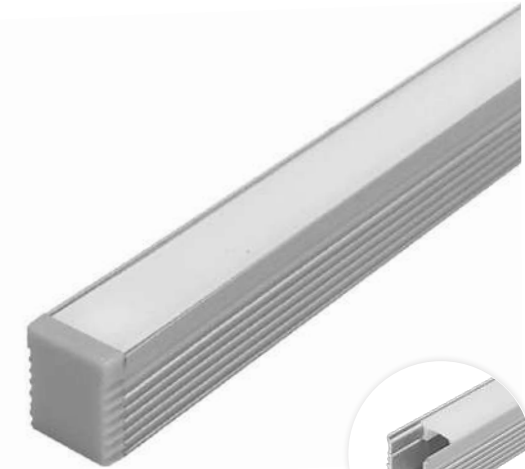

Incluye: kit de instalación
4 grapas y 4 tapas

Dimensiones

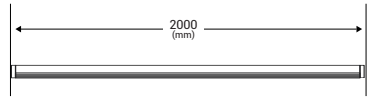
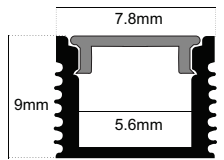

JAPF-0609B

Índice de Protección	IP20
Tira recomendada	JLTL-2835-05120
Material	Aluminio anodizado



Incluye: kit de instalación
4 grapas y 4 tapas

Dimensiones

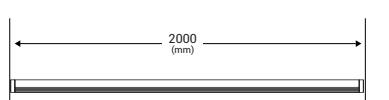
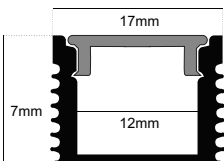

JAPF-1707B

Índice de Protección	IP20
Tira recomendada	JLTL-2835-08120 JLTL-2835-10240 JLTL-COB320
Material	Aluminio anodizado

Accesorios

**No incluidos se vende por separado*



Fuente de alimentación
Disponible en
60W / 100W / 200W / 300W



Tira led para perfil
Disponible en
25W / 55W / 60W / 100W

JAPF

Perfiles de aluminio para led



ESCANEA
ficha técnica

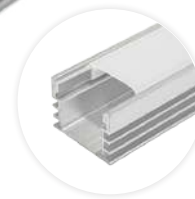

Incluye: kit de instalación
4 grapas y 4 tapas

Dimensiones

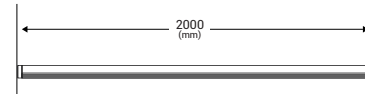
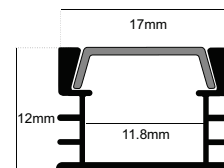

JAPF-1712B

Índice de Protección	IP20
Tira recomendada	JLTL-2835-08120 JLTL-2835-10240 JLTL-COB320
Material	Aluminio anodizado



Incluye: kit de instalación
4 grapas y 4 tapas

Dimensiones

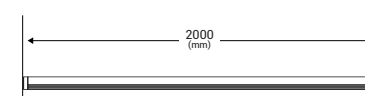
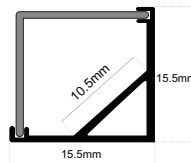

JAPF-1616C

Índice de Protección	IP20
Tira recomendada	JLTL-2835-08120 JLTL-2835-10240 JLTL-COB320
Material	Aluminio anodizado

Accesorios

*No incluidos se vende por separado



Fuente de alimentación
Disponible en
60W / 100W / 200W / 300W



Tira led para perfil
Disponible en
25W / 55W / 60W / 100W

JAPF

Perfiles de aluminio para led



ESCANEA
ficha técnica



Incluye: kit de instalación
4 grapas y 4 tapas

Dimensiones

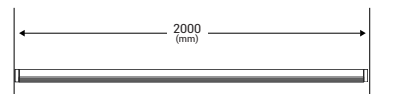
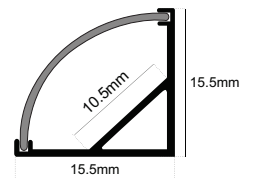

JAPF-1616R

Índice de Protección	IP20
Tira recomendada	JLTL-2835-08120 JLTL-2835-10240 JLTL-COB320
Material	Aluminio anodizado



Incluye: kit de instalación
4 grapas y 4 tapas

Dimensiones

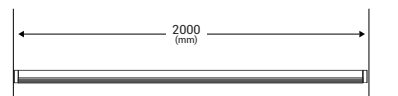
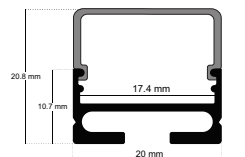

JAPF-2020

Índice de Protección	IP20
Tira recomendada	JLTL-2835-10240
Material	Aluminio anodizado

Accesorios

*No incluidos se vende por separado



Fuente de alimentación
Disponible en
60W / 100W / 200W / 300W



Tira led para perfil
Disponible en
25W / 55W / 60W / 100W

JAPF

Perfiles de aluminio para led



ESCANEA
ficha técnica



Incluye: kit de instalación
4 grapas y 4 tapas

Dimensiones

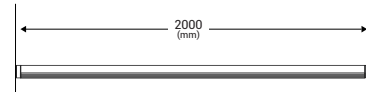
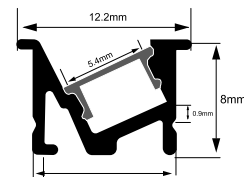

JAPF-1008N / JAPF-1008S

Índice de Protección	IP20
Tira recomendada	JLTL-2835-08120 JLTL-2835-10240 JLTL-COB320
Material	Aluminio anodizado
Acabado	Satinado/Negro



Incluye: kit de instalación
4 grapas y 4 tapas

Accesorios

*Unicos para este modelo
*No incluidos se vende por separado

JAPF-ACC-01



Dimensiones

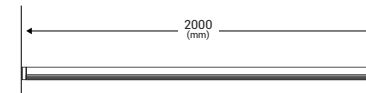
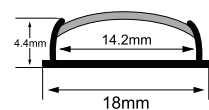

JAPF-1806

Índice de Protección	IP20
Tira recomendada	JLTL-2835-08120 JLTL-2835-10240 JLTL-COB320
Material	Aluminio anodizado

Accesorios

*No incluidos se vende por separado



Fuente de alimentación
Disponible en
60W / 100W / 200W / 300W



Tira led para perfil
Disponible en
25W / 55W / 60W / 100W

JAPF

Perfiles de aluminio para led



ESCANEA
ficha técnica



Incluye: kit de instalación
4 tapas

Dimensiones

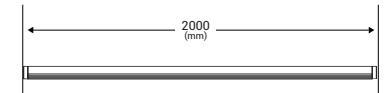
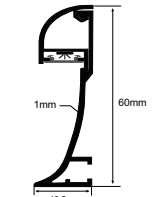

JAPF-6014

Índice de Protección	IP20
Tira recomendada	JLTL-2835-08120 JLTL-2835-10240 JLTL-COB320
Material	Aluminio anodizado



Incluye: kit de instalación
4 tapas

Dimensiones



JAPF-7070

Índice de Protección	IP20
Tira recomendada	JLTL-2835-10240
Material	Aluminio anodizado

Accesorios

*No incluidos se vende por separado



Fuente de alimentación
Disponible en
60W / 100W / 200W / 300W



Tira led para perfil
Disponble en
25W / 55W / 60W / 100W



Línea Tiras y Mangueras

JLTL Tira led para perfil



ESCANEA
ficha técnica



JLTL-2835-05120

Potencia	25W
Tono de luz	
Tensión	24VDC
Corte	Cada 5cm
Longitud	(A)5000mm + (B)5mm

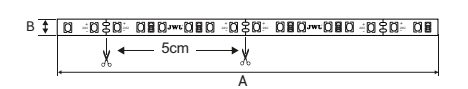

JLTL-2835-08120

Potencia	55W
Tono de luz	
Tensión	24VDC
Corte	Cada 5cm
Longitud	(A)5000mm + (B)8mm

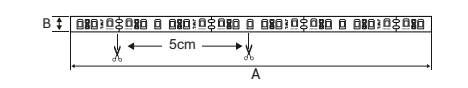

JLTL-2835-10240

Potencia	100W
Tono de luz	
Tensión	24VDC
Corte	Cada 2.5cm
Longitud	(A)5000mm + (B)10mm

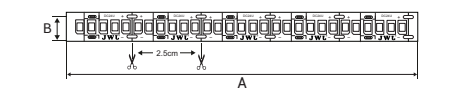

JLTL-COB320

Potencia	60W
Tono de luz	
Tensión	24VDC
Corte	Cada 5cm
Longitud	(A)5000mm + (B)8mm

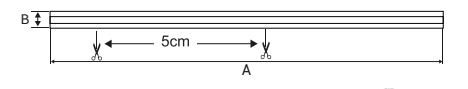

Accesorios

**No incluidos se vende por separado*



Fuente de alimentación
Disponible en
60W / 100W / 200W / 300W



Perfil led de aluminio
Disponible en
10 modelos diferentes



JPY

Fuente de alimentación



24 VDC Salida

IP20 Índice de Protección



ESCANEA
ficha técnica



JPY-12

Potencia	60W
Corriente Eléctrica	550mA - 280mA
Tensión	110V~50/60Hz 220V~50/60Hz
Voltaje de salida	DC-24V
Dimensiones	(A) 115mm • (B) 49mm • (C) 23mm



JPY-13

Potencia	100W
Corriente Eléctrica	900mA - 460mA
Tensión	110V~50/60Hz 220V~50/60Hz
Voltaje de salida	DC-24V
Dimensiones	(A) 138mm • (B) 49mm • (C) 23mm



JPY-14

Potencia	200W
Corriente Eléctrica	1,81A - 910mA
Tensión	110V~50/60Hz 220V~50/60Hz
Voltaje de salida	DC-24V
Dimensiones	(A) 179mm • (B) 49mm • (C) 23mm



JPY-15

Potencia	300W
Corriente Eléctrica	2,72A - 1,37A
Tensión	110V~50/60Hz 220V~50/60Hz
Voltaje de salida	DC-24V
Dimensiones	(A) 210mm • (B) 63mm • (C) 27mm

Dimensiones

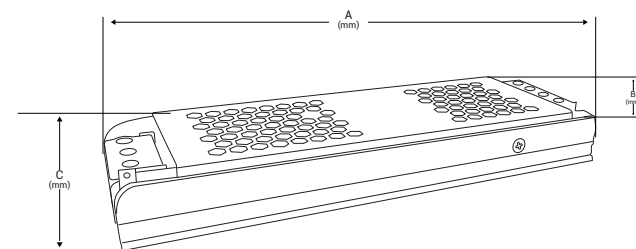

Accesorios

*No incluidos se vende por separado



Tira led para perfil

Disponible en
25W / 55W / 60W / 100W



JLTL

Tira led 5 metros



ESCANEA
ficha técnica



JLTL-3528

Potencia	15W
Tono de luz	Blanco Cálido Rojo Azul Verde
Flujo Luminoso	800 lm
Tensión	DC-12V
Índice de protección	IP65
Dimensiones	(A)5000mm • (B)8mm

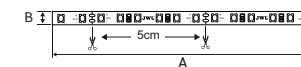

JLTL-3528

Potencia	24W
Tono de luz	Blanco Cálido Rojo Azul Verde
Flujo Luminoso	800 lm
Tensión	DC-12V
Índice de protección	IP20
Dimensiones	(A)5000mm • (B)8mm

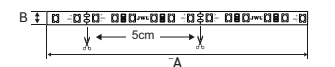

JLTL-5050

Potencia	22W
Tono de luz	Blanco Cálido Rojo Azul Verde
Flujo Luminoso	800 lm
Tensión	DC-12V
Índice de protección	IP20 / IP65
Dimensiones	(A)5000mm • (B)10mm

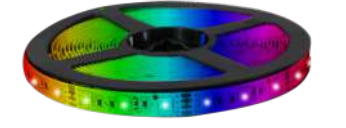
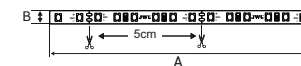

JLTL-5050 RGB

Potencia	22W
Tono de luz	Multicolor
Flujo Luminoso	800 lm
Tensión	DC-12V
Índice de protección	IP20 / IP65
Dimensiones	(A)5000mm • (B)10mm

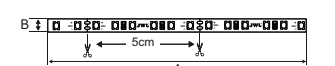

Accesorios

*No incluidos se vende por separado



JPY-01
Adaptador de corriente
Para tiras led P/3528.
Entrada AC127V / Salida DC12V.



JPY-03
Adaptador de corriente
Para tiras led RGB.
Entrada AC127V / Salida DC12V.



JPY-04
Adaptador de corriente
Para tiras led P/5050.
Entrada AC127V / Salida DC12V.

JLML

Manguera led 25 metros



JLML-5050

Potencia	150W
Tono de luz	Blanco Cálido Rojo Azul Verde
Tensión	DC-45-110V
Dimensiones	(A)25000mm (B)10mm

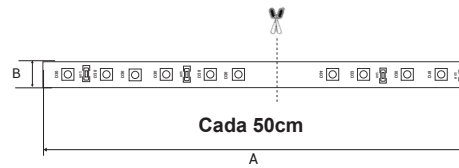

JLML-5050RGB

Potencia	150W
Tono de luz	Multicolor RGB
Tensión	DC-45-110V
Dimensiones	(A)25000mm (B)10mm

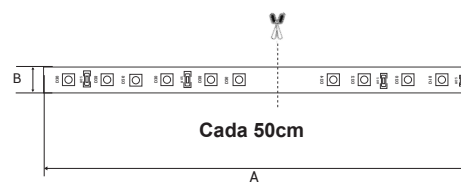

ESCANEA
ficha técnica

Accesorios



JLPM-03 8mm
1 RECTIFICADOR



ESCANEA
ficha técnica

Accesorios



JLPM-02
1 RECTIFICADOR
Con mando de control RGB.
Efectos de controlador
(1)Combinación (2)Olas (3)Permanente
(4)Resplandor lento (5)Persiguiendo
(6)Desvanecido lento (7)Twinkle (8) Apagado.

*No incluido se vende por separado



JLPM-01
Adaptador de corriente
Con control remoto RGB.



JUML

Manguera led redonda



JUML 2835-06

Potencia	150W
Tono de luz	Blanco Cálido Rojo Azul Verde
Tensión	127V~ 60Hz
Dimensiones	(A)50000mm (B)10mm

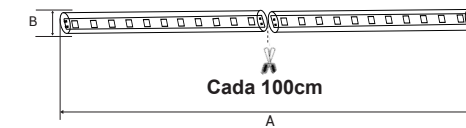

JUML 2835-06RGB

Potencia	150W
Tono de luz	Multicolor RGB
Tensión	127V~ 60Hz
Dimensiones	(A)50000mm (B)10mm

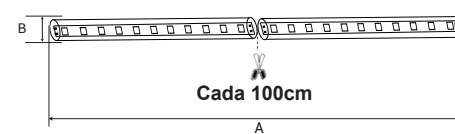

ESCANEA
ficha técnica

Accesorios



JLPM-11 6mm
1 RECTIFICADOR



ESCANEA
ficha técnica

Accesorios



JLPM-12 6mm
1 RECTIFICADOR



JLML

Manguera led 50 metros



JUML-2835-07

Potencia	500W
Tono de luz	6500 K Luz Fria — 2700 K Luz Calida
Tensión	110 VAC
Dimensiones	(A)50000mm (B)10mm

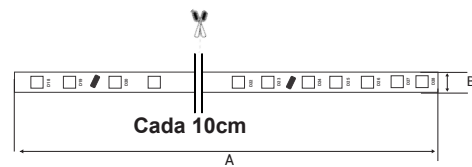

JUML-2835-08

Potencia	500W
Tono de luz	6500 K Luz Fria — 2700 K Luz Calida
Tensión	110 VAC
Dimensiones	(A)50000mm (B)10mm

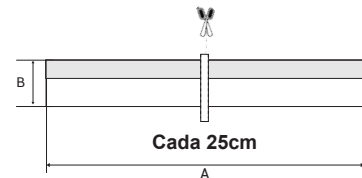

ESCANEA
ficha técnica

Accesorios



JLPM-13
2 CONECTORES
con grapas de sujeción



ESCANEA
ficha técnica

Accesorios



JLPM-15
2 RECTIFICADORES
con grapas de sujeción



JUML

Manguera 1 led 50 metros



JUML-2835-01

Potencia	300W
Tono de Luz	6500 K Luz Fria — 2700 K Luz Calida
Tensión	DC 45-110V
Dimensiones	(A)50000mm • (B)15mm

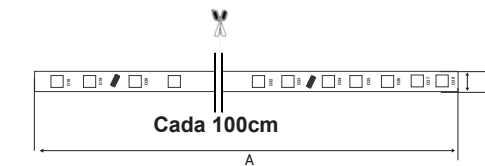

Manguera 3 led 's 50 metros



JUML-2835-02

Potencia	300W
Tono de Luz	6500 K Luz Fria — 2700 K Luz Calida
Tensión	DC 45-110V
Dimensiones	(A)50000mm • (B)15mm

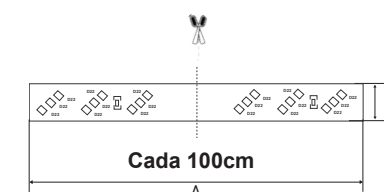

ESCANEA
ficha técnica

Accesorios



JLPM-04 5MM
2 RECTIFICADORES
con grapas de sujeción



ESCANEA
ficha técnica

Accesorios



JLPM-04 12MM
2 RECTIFICADORES
con grapas de sujeción



JUML

Manguera 1 led 50 metros



JUML-5050

Potencia	300W
Tono de Luz	Blanco Cálido Rojo Azul Verde
Tensión	DC 45-110V
Dimensiones	(A)50000mm • (B)10mm

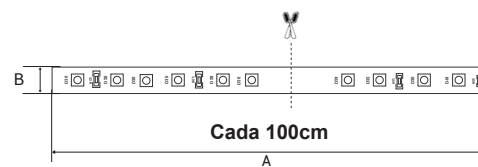

ESCANEA
ficha técnica

Accesorios



JLPM-03 8mm
2 RECTIFICADORES
con grapas de sujeción



ESCANEA
ficha técnica

Accesorios



JLPM-06
2 RECTIFICADORES
con grapas de sujeción



JUML

Manguera 1 led 25 metros



JUML-5050-01

Potencia	150W
Tono de Luz	Multicolor RGB
Tensión	DC 45-110V
Dimensiones	(A)25000mm • (B)10mm

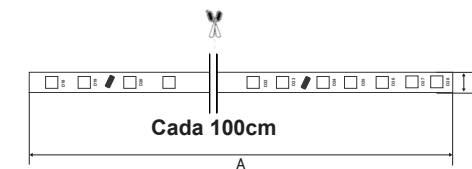

ESCANEA
ficha técnica

Accesorios



JLPM-07 10mm
2 RECTIFICADORES
con grapas de sujeción y mando de control RGB.



JLPM-08 10mm
Adaptador de corriente
con control remoto RGB.
**No incluido se vende por separado*



ESCANEA
ficha técnica

Accesorios



JLPM-07 10mm
2 RECTIFICADORES
con grapas de sujeción y mando de control RGB.



JLPM-08 10mm
Adaptador de corriente
con control remoto RGB.
**No incluido se vende por separado*



Manguera 2 led's 50 metros



JUML-5730-01

Potencia	300W
Tono de Luz	2700 K Luz Cálida
Tensión	DC 45-110V
Dimensiones	(A)50000mm • (B)10mm

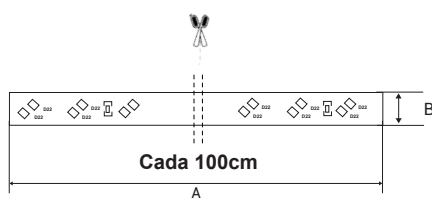

Manguera 1 led 50 metros



JUML-5050-01

Potencia	300W
Tono de Luz	Multicolor RGB
Tensión	DC 45-110V
Dimensiones	(A)50000mm • (B)10mm

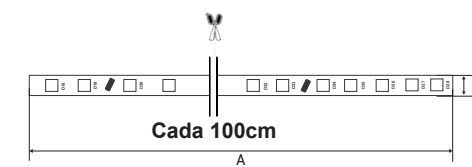

Exteriores



JUML

Manguera 2 led´s 25 metros



ESCAÑEA
ficha técnica



JUML-5050-02

Potencia	150W
Tono de Luz	Multicolor
Tensión	DC 45-110V
Dimensiones	(A)25000 mm • (B)15mm

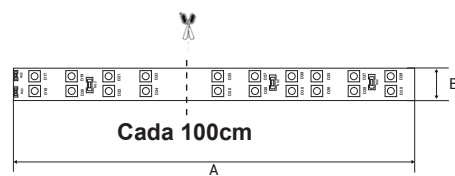

Accesorios



JLPM-07 12mm
1 RECTIFICADORES
con grapas de sujeción y mando de control RGB.



JLPM-08 12mm
Adaptador de corriente
con control remoto RGB.

**No incluido se vende por separado*

Exteriores



JUML

Manguera neón 50 metros



ESCAÑEA
ficha técnica



JUML-2835-03

Potencia	300W
Tono de Luz	Blanco Cálido Rojo Azul Verde
Tensión	DC 45-110V
Dimensiones	(A)50000 mm • (B)15mm

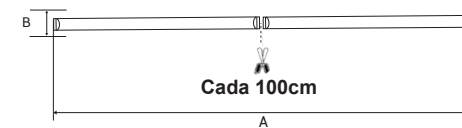

Accesorios



JLPM-05
2 RECTIFICADORES
con grapas de sujeción.

JUML-5050RGB-03

Manguera neón 50 metros

Índice de protección
 Ángulo de luz
 Instalación: Sobrepone con Clips de Sujeción
 No Dimeable



ESCANEA
ficha técnica



JUML-5050RGB-03

Potencia **300 W**

Tono de Luz Multicolor

Tensión DC 45 - 100V

Dimensiones

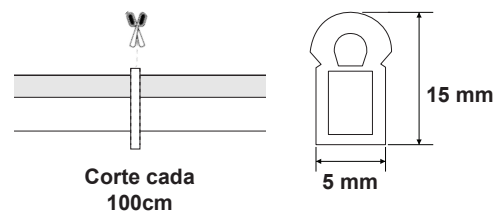

Accesorios

*No incluidos se vende por separado



JLPM-10
Adaptador de corriente con control remoto RGB.

JUNF-2835

Tira led neón 5 metros

Índice de protección
 Ángulo de luz
 Instalación: Sobrepone con Clips de Sujeción
 No Dimeable



ESCANEA
ficha técnica



JUNF-2835

Potencia **50 W**

Tono de Luz

Tensión 12 V

Accesorios

*No incluidos se vende por separado



JPY-04
Adaptador de corriente
Para tira led JUNF-2835.
Entrada AC127V / Salida DC12V

Dimensiones

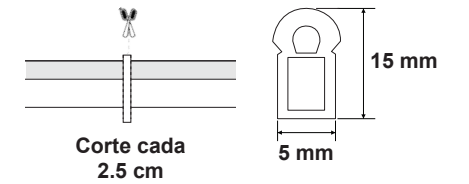

JUNF-5050RGB

Tira led neón 5 metros



ESCANEA
ficha técnica

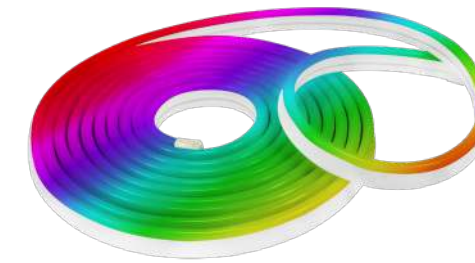

JUML-5050RGB

Potencia **50 W**

Tono de Luz Multicolor

Tensión 12VDC

Dimensiones

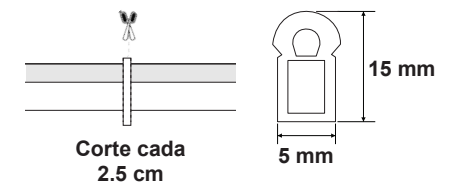

Accesorios

*No incluidos se vende por separado



JPY-03
Adaptador de corriente
Para tira led Neón RGB.
Entrada AC127V / Salida DC12V



JUML-2936

Modulo LED



ESCANEA
ficha técnica

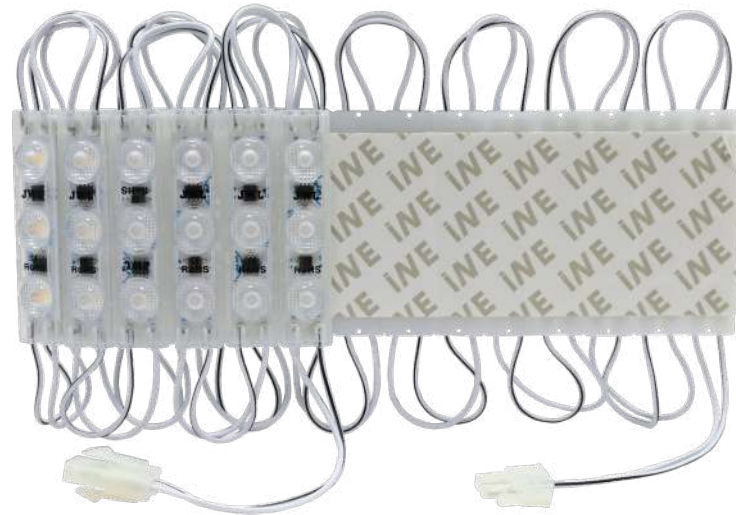

JUML-2936

Potencia	50W
Tono de Luz	6500 K Luz Fria — 2700 K Luz Cálida
Flujo Luminoso	4 500 lm
Tensión	110 VAC
Corriente Eléctrica	360 mA
Serie	20 Módulos
Dimensiones	(A) 320mm (B) 72mm (C) 16mm

Dimensiones

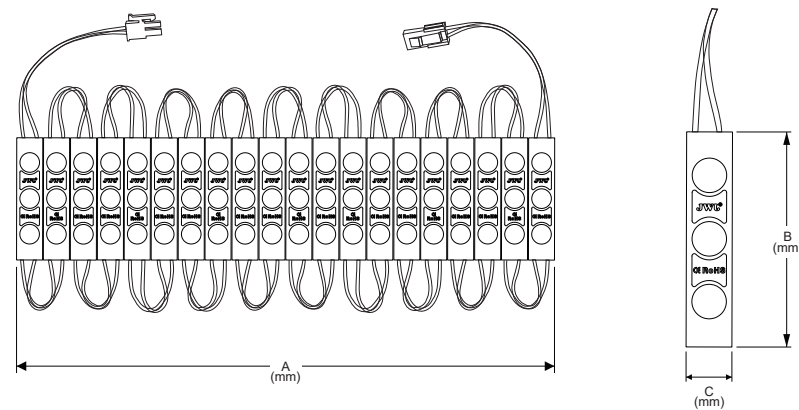

JLES-212

Arbotante de pared



ESCANEA
ficha técnica



JLES-212

Potencia	12W
Tono de Luz	6500 K Luz Fria
Flujo Luminoso	840 lm
Tensión	127V~50/60Hz
Corriente Eléctrica	255 mA
Dimensiones	(A) 405mm (B) 58mm (C) 60mm

Dimensiones

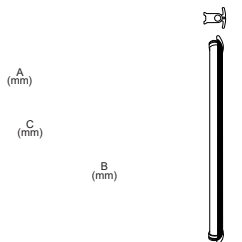

JLES-312

Arbotante de pared



ESCANEA
ficha técnica



JLES-312

Potencia	12 W
Tono de Luz	6500 K Luz Fria
Flujo Luminoso	840 lm
Tensión	127V~60Hz
Corriente Eléctrica	255 mA
Dimensiones	(A) 448 mm (B) 107mm (C) 23mm

Dimensiones

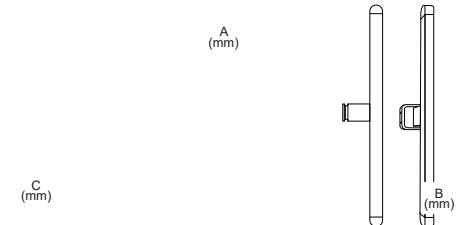

Línea Ventiladores



JLV-01

Ventilador de techo led



ESCANEA
ficha técnica



Dimensiones

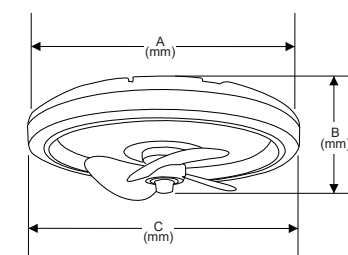

JLV-01(1)

Potencia	88W máx.
Tono de Luz	6500 K Luz Fria 4000 K Luz Neutra 2700 K Luz Calida
Flujo Luminoso	4 500 lm
Tensión	110V~50/60Hz
Corriente Eléctrica	800 mA
Dimensiones	(A) 446mm (B) 132mm (C) 479mm



ESCANEA
ficha técnica



Dimensiones

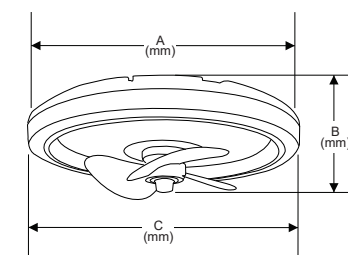

JLV-01(2)

Potencia	88W máx.
Tono de Luz	6500 K Luz Fria 4000 K Luz Neutra 2700 K Luz Calida
Flujo Luminoso	4 500 lm
Tensión	110V~50/60Hz
Corriente Eléctrica	800 mA
Dimensiones	(A) 395mm (B) 132mm (C) 475mm



Interiores

JLV-0112

Ventilador de techo led

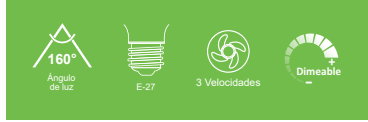

ESCANEA
ficha técnica



JLV-0112

Potencia	40 W
Tono de Luz	6500 K Luz Fria, 4000 K Luz Neutra, 2700 K Luz Calida
Base	E-27
Corriente Eléctrica	350 mA
Tensión	110V~50/60Hz
Dimensiones	(A) 250mm (B) 257mm



Dimensiones

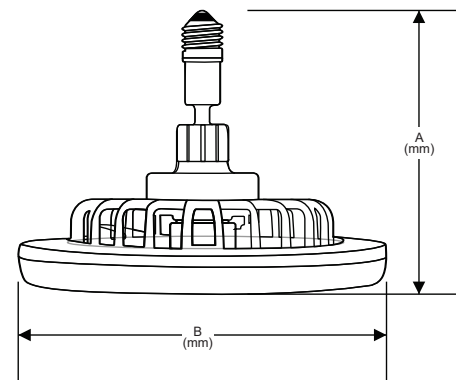

5 74

Interiores

JLV-01

Ventilador de techo led 360°



ESCANEA
ficha técnica



Dimensiones

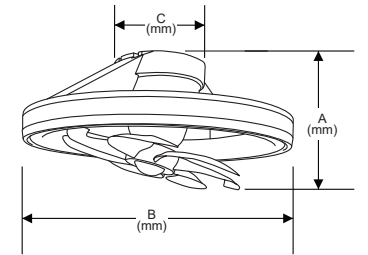

JLV-01 (3)

Potencia	88 W máx.
Tono de Luz	6500 K Luz Fria, 4000 K Luz Neutra, 2700 K Luz Calida
Flujo Luminoso	4 500 lm
Tensión	110V~50/60Hz
Corriente Eléctrica	800 mA
Dimensiones	(A) 220mm (B) 475mm (C) 174 mm



Dimensiones

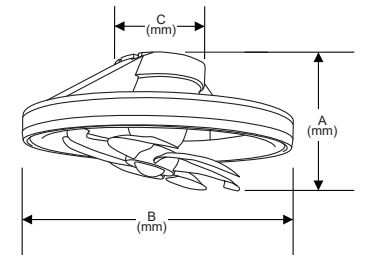

JLV-01 (4)

Potencia	88 W máx.
Tono de Luz	6500 K Luz Fria, 4000 K Luz Neutra, 2700 K Luz Calida
Flujo Luminoso	4 500 lm
Tensión	110V~50/60Hz
Corriente Eléctrica	800 mA
Dimensiones	(A) 220mm (B) 475mm (C) 174 mm



75

Interiores

JLV-01

Ventilador de techo led 360°



ESCANEAR
ficha técnica



Dimensiones

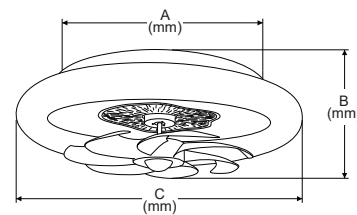

JLV-01 (5)

Potencia	88 W máx.
Tono de Luz	6500 K Luz Fria, 4000 K Luz Neutra, 2700 K Luz Calida
Flujo Luminoso	5 400 lm
Tensión	110V~50/60Hz
Corriente Eléctrica	800 mA
Dimensiones	(A) 395mm (B) 154mm (C) 550mm



ESCANEAR
ficha técnica



Dimensiones

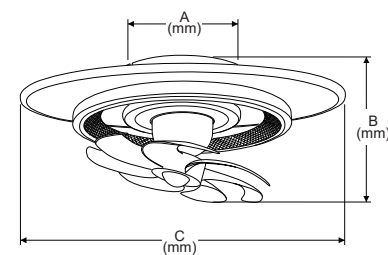

JLV-01 (6)

Potencia	88 W máx.
Tono de Luz	6500 K Luz Fria, 4000 K Luz Neutra, 2700 K Luz Calida
Flujo Luminoso	5 400 lm
Tensión	110V~50/60Hz
Corriente Eléctrica	800 mA
Dimensiones	(A) 250mm (B) 198mm (C) 550mm



76

Interiores

JLV-02

Ventilador de techo led



ESCANEAR
ficha técnica



Dimensiones

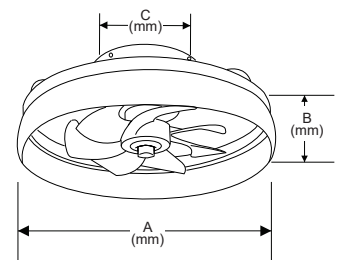

JLV-02 (1)

Potencia	88 W máx.
Tono de Luz	6500 K Luz Fria, 4000 K Luz Neutra, 2700 K Luz Calida
Flujo Luminoso	4 500 lm
Tensión	110V~50/60Hz
Corriente Eléctrica	800mA
Dimensiones	(A) 400mm (B) 180mm (C) 200 mm



ESCANEAR
ficha técnica



Dimensiones

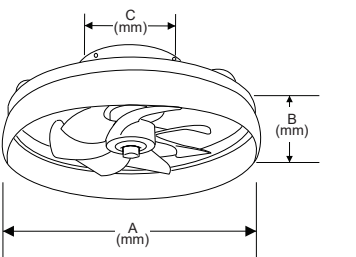

JLV-02 (2)

Potencia	88 W máx.
Tono de Luz	6500 K Luz Fria, 4000 K Luz Neutra, 2700 K Luz Calida
Flujo Luminoso	4 500 lm
Tensión	110V~50/60Hz
Corriente Eléctrica	800mA
Dimensiones	(A) 450mm (B) 195mm (C) 200mm



77

JLV-02

Ventilador de techo led



ESCANEA
ficha técnica

JLV-02 (3)

Potencia	88 W máx.
Tono de Luz	6500 K Luz Fria 4000 K Luz Neutra 2700 K Luz Calida
Flujo Luminoso	4 500 lm
Tensión	110V~50/60Hz
Corriente Eléctrica	800mA
Dimensiones	(A) 480mm (B) 140mm (C) 300mm

Dimensiones

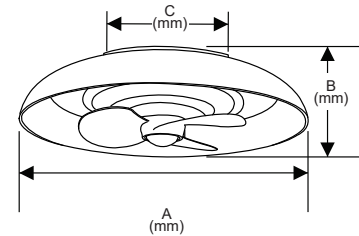

ESCANEA
ficha técnica

JLV-02 (6)

Potencia	40 W máx.
Base	E-27
Tensión	110V~50/60Hz
Corriente Eléctrica	800mA
Dimensiones	(A) 193mm (B) 277mm (C) 505mm

Dimensiones

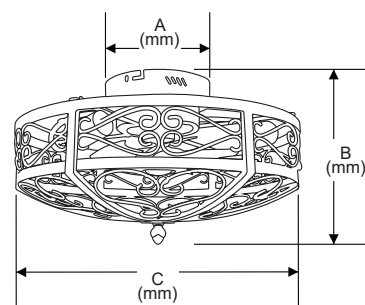

Accesorios

*No incluidos se vende por separado



JLV-02

Ventilador de techo led

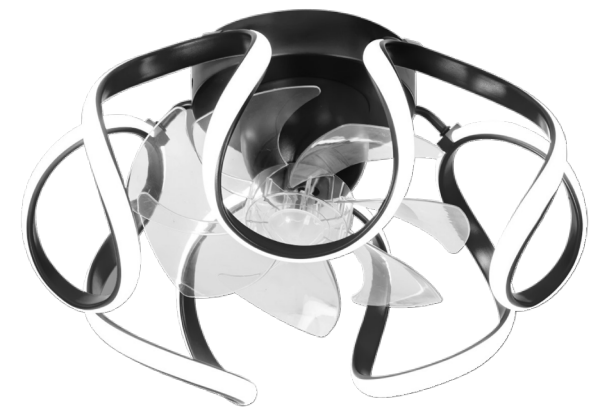

ESCANEA
ficha técnica

JLV-02 (5)

Potencia	88 W máx.
Tono de Luz	6500 K Luz Fria 4000 K Luz Neutra 2700 K Luz Calida
Flujo Luminoso	4 500 lm
Tensión	110V~50/60Hz
Corriente Eléctrica	800mA
Dimensiones	(A) 600mm (B) 180mm

Dimensiones

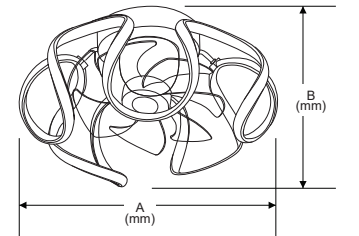

ESCANEA
ficha técnica



Dimensiones

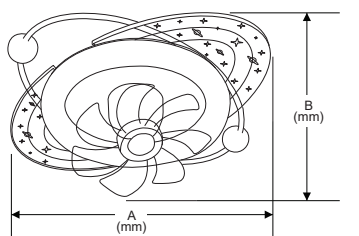

JLV-02 (7)

Potencia	88 W máx.
Tono de Luz	6500 K Luz Fria 4000 K Luz Neutra 2700 K Luz Calida
Flujo Luminoso	4 500 lm
Tensión	110V~50/60Hz
Corriente Eléctrica	800mA
Dimensiones	(A) 600mm (B) 180mm



JLV-02

Ventilador de techo led



ESCANEA
ficha técnica



JLV-02 (8)

Potencia	88 W máx.
Tono de Luz	6500 K Luz Fria, 4000 K Luz Neutra, 2700 K Luz Cálida
Flujo Luminoso	5 400 lm
Tensión	110V~50/60Hz
Corriente Eléctrica	800 mA
Dimensiones	(A) Ø394mm (B) 205mm (C) Ø495mm

Dimensiones

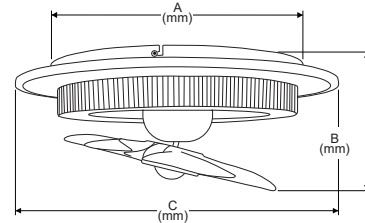

ESCANEA



JLV-02 (9)

Potencia	88 W máx.
Tono de Luz	6500 K Luz Fria, 4000 K Luz Neutra, 2700 K Luz Cálida
Flujo Luminoso	5 400 lm
Tensión	110V~50/60Hz
Corriente Eléctrica	800 mA
Dimensiones	(A) 458mm (B) 130mm (C) 504mm

Dimensiones

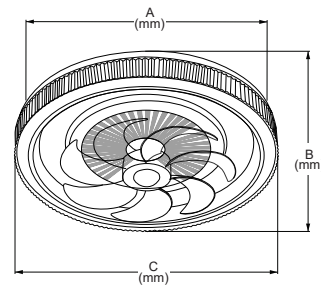

JLV-03

Ventilador de techo led



ESCANEA
ficha técnica



JLV-03 (1)

Potencia	88 W máx.
Tono de Luz	6500 K Luz Fria, 4000 K Luz Neutra, 2700 K Luz Cálida
Flujo Luminoso	4 500 lm
Tensión	110V~50/60Hz
Corriente Eléctrica	800 mA
Dimensiones	(A) 500mm • (B) 500mm (C) 150mm • (D) 1075mm



Dimensiones

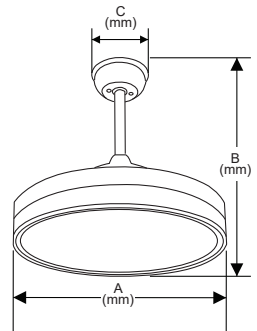

JLV-03 (2)

Potencia	88 W máx.
Tono de Luz	6500 K Luz Fria, 4000 K Luz Neutra, 2700 K Luz Cálida
Flujo Luminoso	4 500 lm
Tensión	110V~50/60Hz
Corriente Eléctrica	800 mA
Dimensiones	(A) 500mm • (B) 500mm (C) 150mm • (D) 1075mm

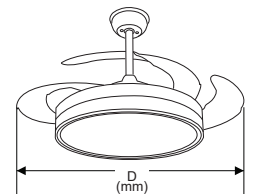

JLV-03

Ventilador de techo led



ESCANEA
ficha técnica



JLV-03 (5)

Potencia	88 W máx.
Tono de Luz	6500 K Luz Fria, 4000 K Luz Neutra, 2700 K Luz Calida
Flujo Luminoso	5 400 lm
Tensión	110-130V~50/60Hz
Corriente Eléctrica	800 mA
Dimensiones	(A) 490mm (B) 390mm (C) 145mm (D) 1000mm



Dimensiones

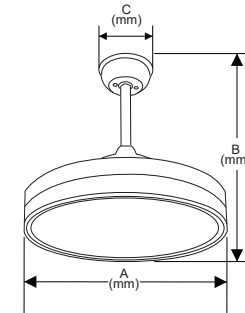

JLV-03 (6)

Potencia	88 W máx.
Tono de Luz	6500 K Luz Fria, 4000 K Luz Neutra, 2700 K Luz Calida
Flujo Luminoso	5 400 lm
Tensión	110-130V~50/60Hz
Corriente Eléctrica	800 mA
Dimensiones	(A) 490mm (B) 390mm (C) 145mm (D) 1000 mm

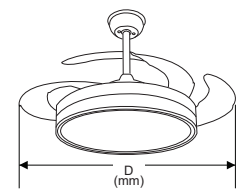

JLV-04

Ventilador de techo led



ESCANEA
ficha técnica



JLV-04 (1)

Potencia	88 W máx.
Tono de Luz	6500 K Luz Fria, 4000 K Luz Neutra, 2700 K Luz Calida
Flujo Luminoso	4 500 lm
Tensión	110V~50/60Hz
Corriente Eléctrica	800 mA
Dimensiones	(A) 500mm (B) 580mm (C) 150mm (D) 1075mm



Dimensiones

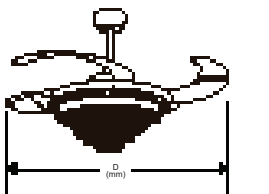
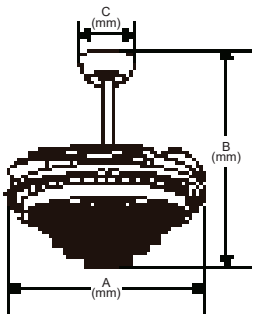

JLV-04 (2)

Potencia	88 W máx.
Tono de Luz	6500 K Luz Fria, 4000 K Luz Neutra, 2700 K Luz Calida
Flujo Luminoso	4 500 lm
Tensión	110V~50/60Hz
Corriente Eléctrica	800 mA
Dimensiones	(A) 490mm (B) 580mm (C) 150mm (D) 1075mm



ESCANEA
ficha técnica



Interiores



JLV-04

Ventilador de techo led



ESCANEA
ficha técnica



Dimensiones

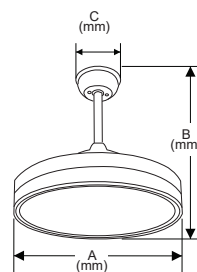

JLV-04 (3)

Potencia	88 W máx.
Tono de Luz	6500 K Luz Fria, 4000 K Luz Neutra, 2700 K Luz Calida
Flujo Luminoso	5 400 lm
Tensión	110-130V~50/60Hz
Corriente Eléctrica	800 mA
Dimensiones	(A) 150mm • (B) 420mm • (C) 470mm



ESCANEA
ficha técnica

JLV-05

Ventilador de techo led



Dimensiones

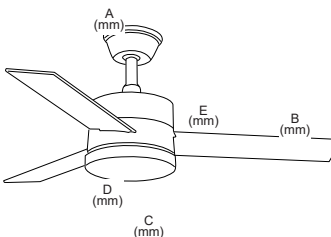

JLV-05

Potencia	88 W máx.
Tono de Luz	6500 K Luz Fria, 4000 K Luz Neutra, 2700 K Luz Calida
Flujo Luminoso	4 500 lm
Tensión	110V~50/60Hz
Corriente Eléctrica	800 mA
Dimensiones	(A) 150mm (B) 380mm (C) 1705mm (D) 220mm (E) 465mm



Interiores



JLV-06

Ventilador de techo led



ESCANEA
ficha técnica



JLV-06

Potencia	88 W máx.
Tono de Luz	6500 K Luz Fria, 4000 K Luz Neutra, 2700 K Luz Calida
Flujo Luminoso	4 500 lm
Tensión	110V~50/60Hz
Corriente Eléctrica	800 mA
Dimensiones	(A) 215mm • (B) 300mm • (C) 565mm (D) 1320mm • (E) 210mm

Dimensiones

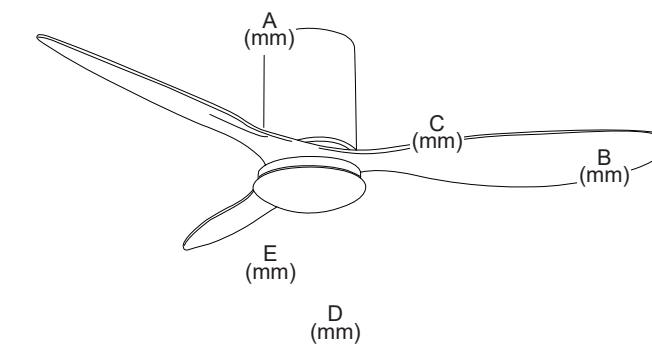

Interiores

JV-003

Ventilador de pedestal

IP20

Índice de protección

60°

Oscilación

3 Velocidades

Silencioso



ESCANEA
ficha técnica



JV-003

Potencia	60 W
Tensión	110V~50Hz
Material	Policarbonato
Dimensiones	(A) 330mm (B) 635-90mm [Ajustable] (C) 330mm

Dimensiones

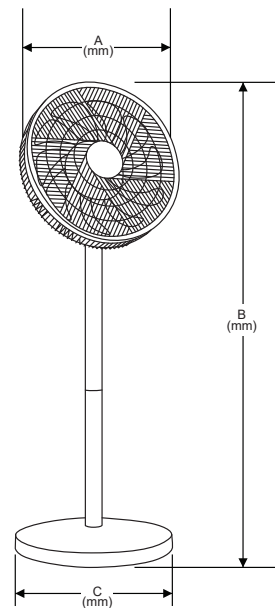

Interiores

JV-004

Ventilador de pedestal

IP20

Índice de protección

80°

Oscilación

3 Velocidades

Silencioso



ESCANEA
ficha técnica



JV-004

Potencia	45 W
Tensión	110V~50Hz
Material	Policarbonato
Dimensiones	(A) 230mm (B) 850mm (C) 310mm

Dimensiones

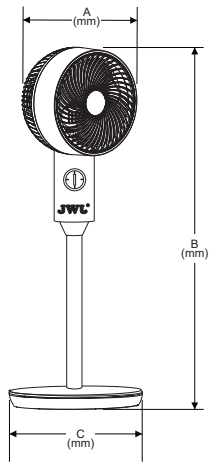

JV-101

Ventilador de pedestal

IP20

Índice de protección

80°-80°

Oscilación

3 Velocidades

Silencioso



ESCANEA
ficha técnica



JV-101

Potencia	50 W
Tensión	110V~50Hz
Material	Policarbonato
Dimensiones	(A) 260mm (B) 80-105mm [Ajustable] (C) 330mm

Dimensiones

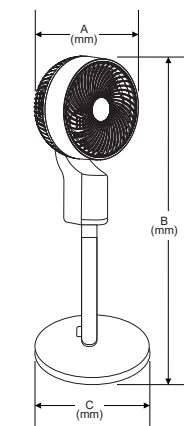

Interiores

JV-005

Ventilador de pared



ESCANEA
ficha técnica

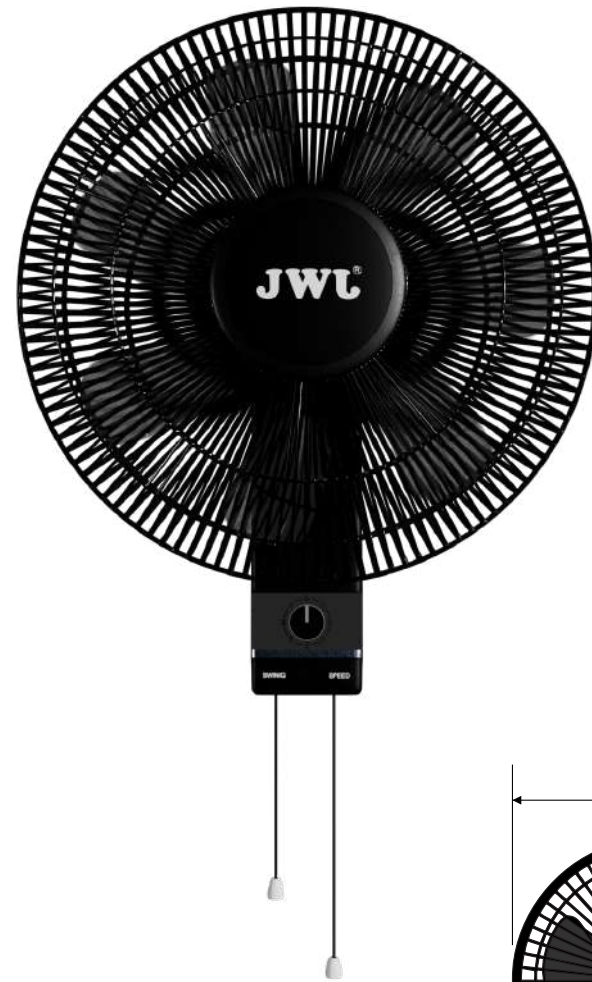

Dimensiones

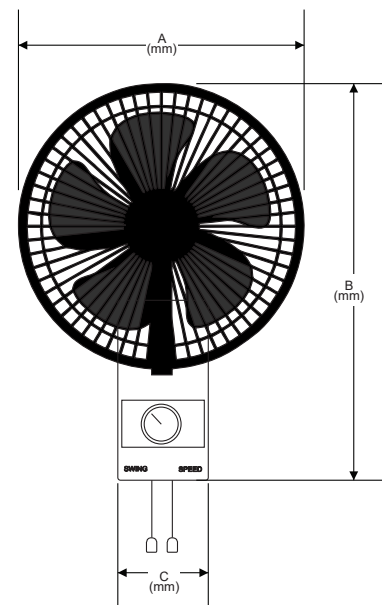

JV-005

Potencia	60 W
Tensión	110V~50Hz
Material	Policarbonato
Dimensiones	(A) 430mm (B) 530mm (C) 115mm



Interiores

JV-103

Ventilador de torre



ESCANEA
ficha técnica



JV-103

Potencia	45 W
Tensión	110V~50Hz
Dimensiones	(A) 135mm (B) 840mm (C) 300mm

Dimensiones

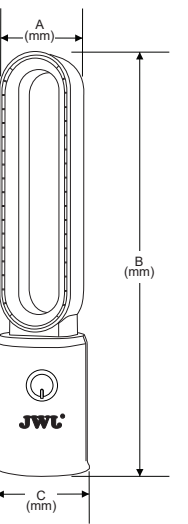

JV-002

Ventilador de torre



ESCANEA
ficha técnica



JV-002

Potencia	55 W
Tensión	110V~50Hz
Material	Policarbonato
Dimensiones	(A) 180mm (B) 970mm (C) 220mm

Dimensiones

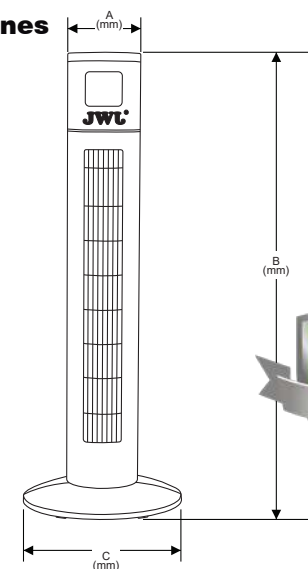



Línea Lámparas de techo

JLAR-3001

Lámpara de techo

- 50 000 h Vida útil
- 120° Ángulo de luz
- Instalación Subyacente
- No Dimeable



ESCAÑEA
ficha técnica



3 EN 1
CAMBIA DE COLOR

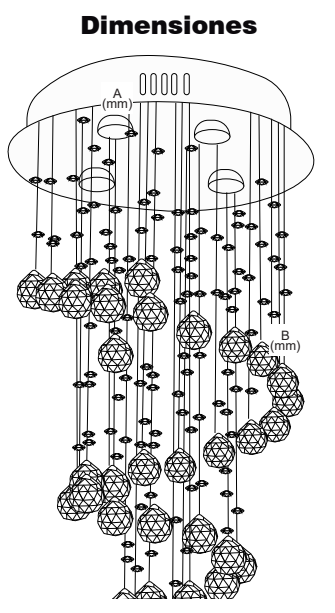

JLAR-3001

Potencia	30 W
Tono de Luz	6500 K Luz Fria 4000 K Luz Neutra 2700 K Luz Calida
Flujo Luminoso	2 400 lm
Tensión	85-265~50/60Hz
Corriente Eléctrica	0.23 A
Dimensiones	(A) 355mm (B) 540mm



Interiores

JLAR-4002

Lámpara de techo



JLAR-4002

Potencia	40 W
Tono de Luz	6500 K Luz Fria Luz Neutra Luz Calida
Flujo Luminoso	3 000 lm
Tensión	85-265~50/60Hz
Corriente Eléctrica	0.30 A
Dimensiones	(A) 479mm (B) 64mm

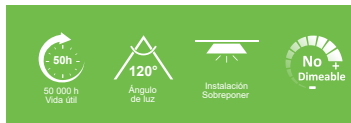

ESCANEAR
ficha técnica

Dimensiones

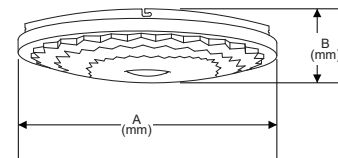

3 EN 1
CAMBIA DE COLOR



ESCANEAR
ficha técnica

JLAR-5002

Lámpara de techo



JLAR-5002

Potencia	50 W
Tono de Luz	6500 K Luz Fria Luz Neutra Luz Calida
Flujo Luminoso	4 000 lm
Tensión	85-265~50/60Hz
Corriente Eléctrica	0.38A
Dimensiones	(A) 133mm (B) 745mm

Dimensiones

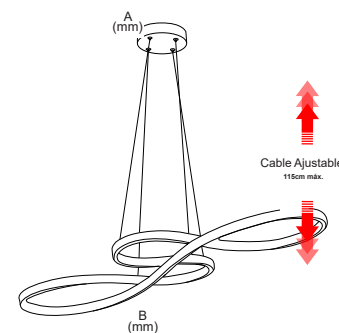

3 EN 1
CAMBIA DE COLOR



Interiores

JLAR-5005

Lámpara de techo



JLAR-5005

Potencia	50 W
Tono de Luz	6500 K Luz Fria Luz Neutra Luz Calida
Flujo Luminoso	4 000 lm
Tensión	85-265~50/60Hz
Corriente Eléctrica	0.38A
Dimensiones	(A) 220mm (B) 1200mm



3 EN 1
CAMBIA DE COLOR

Dimensiones

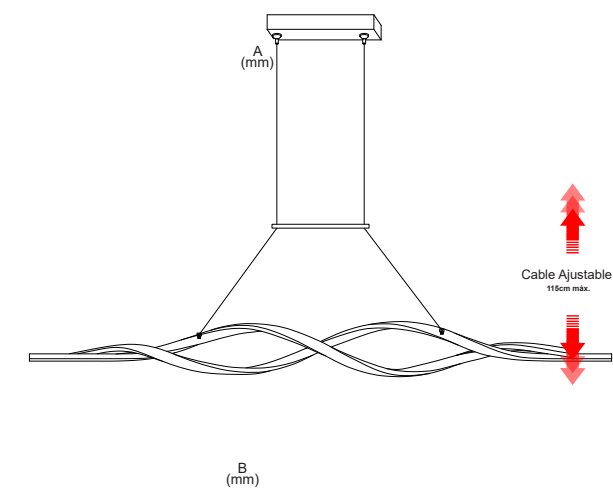



JLAR

Lámpara de techo



JLAR-5007

Potencia	50W
Tono de Luz	
Flujo Luminoso	3 500 lm
Tensión	85-265V~50/60Hz
Corriente Eléctrica	0.38 A
Dimensiones	(A) Ø479mm (B) 64mm

Dimensiones

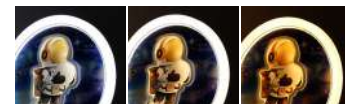
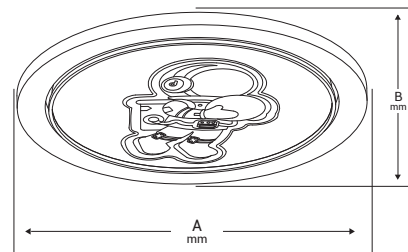

3 EN 1
CAMBIA DE COLOR



ESCANEA
ficha técnica

Dimensiones

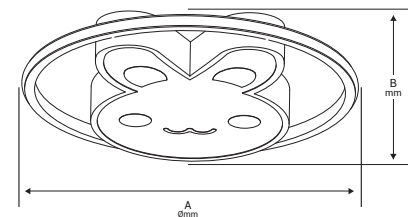

3 EN 1
CAMBIA DE COLOR



JLAR-5006

Potencia	50W
Tono de Luz	
Flujo Luminoso	3 500 lm
Tensión	85-265V~50/60Hz
Corriente Eléctrica	0.38 A
Dimensiones	(A) Ø510mm (B) 62mm

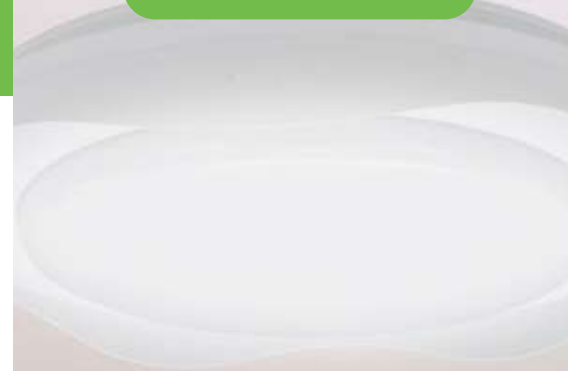

JLAR

Lámpara de techo



JLAR-5009

Potencia	50W
Tono de Luz	
Flujo Luminoso	3 500 lm
Tensión	85-265V~50/60Hz
Corriente Eléctrica	0.38 A
Dimensiones	(A) Ø510mm (B) 62mm

Dimensiones

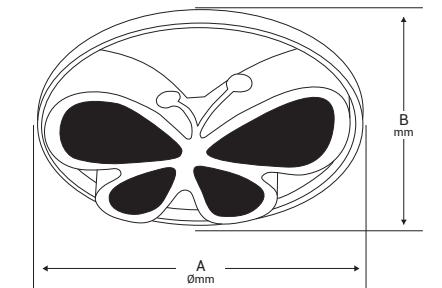

3 EN 1
CAMBIA DE COLOR



ESCANEA
ficha técnica

Dimensiones

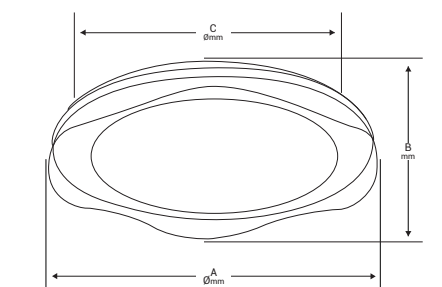

JLAR-5010

Potencia	50W
Tono de Luz	
Flujo Luminoso	3 500 lm
Tensión	85-265V~50/60Hz
Corriente Eléctrica	0.38 A
Dimensiones	(A) Ø510mm (B) 94mm (C) Ø452mm



Interiores

JLAR

Lámpara de techo



ESCANEA
ficha técnica



JLAR-5011

Potencia	50W
Tono de Luz	6500 K Luz Fria
Flujo Luminoso	4 500 lm
Tensión	85-265V~50/60Hz
Corriente Eléctrica	0.39 A
Dimensiones	(A) Ø482mm (B) 83mm (C) Ø452mm

Dimensiones

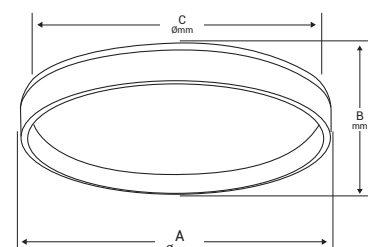

ESCANEA
ficha técnica



JLAR-5012

Potencia	50W
Tono de Luz	6500 K Luz Fria
Flujo Luminoso	4 500 lm
Tensión	85-265V~50/60Hz
Corriente Eléctrica	0.39 A
Dimensiones	(A) Ø495mm (B) 80mm (C) Ø452mm

Dimensiones

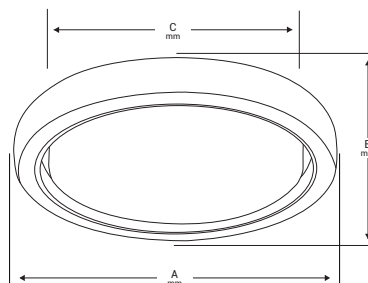

Interiores

JLAR

Lámpara de techo



ESCANEA
ficha técnica



JLAR-5013

Potencia	50W
Tono de Luz	6500 K Luz Fria 4000 K Luz Neutra 2700 K Luz Calida
Flujo Luminoso	4 500 lm
Tensión	85-265V~50/60Hz
Corriente Eléctrica	0.39 A
Dimensiones	(A) Ø489mm (B) 79mm (C) Ø450mm

Dimensiones

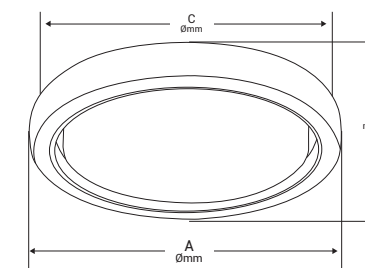

3 EN 1
CAMBIA DE COLOR



ESCANEA
ficha técnica

Dimensiones

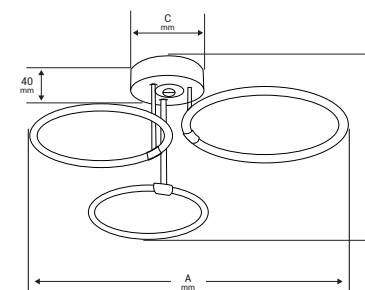

JLAR-5030

Potencia	50W
Tono de Luz	6500 K Luz Fria
Flujo Luminoso	4 250 lm
Tensión	127V~50/60Hz
Corriente Eléctrica	420 mA
Dimensiones	(A) 740mm (B) 185mm (C) Ø140mm



JLAR

Lámpara de techo



ESCANEA
ficha técnica



Dimensiones

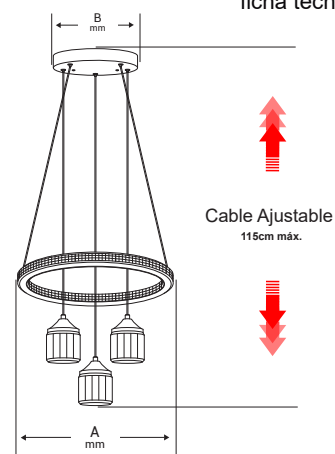

3 EN 1
CAMBIA DE COLOR



ESCANEA
ficha técnica

Dimensiones

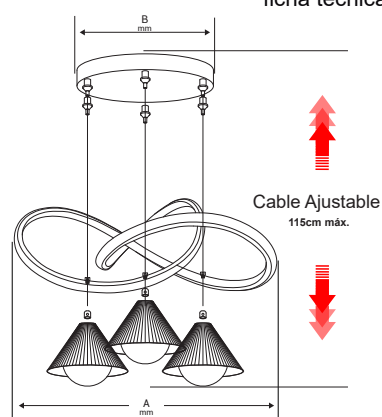

3 EN 1
CAMBIA DE COLOR



JLAR

Lámpara de techo



ESCANEA
ficha técnica

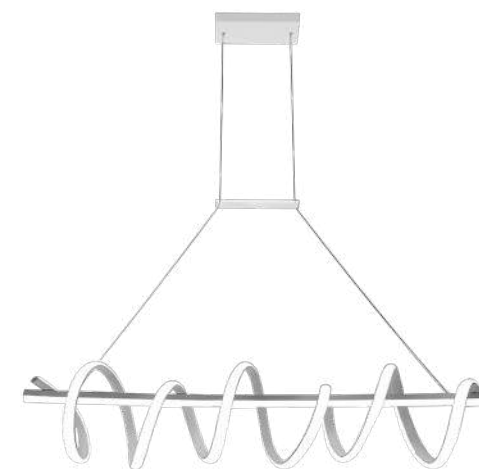

Dimensiones

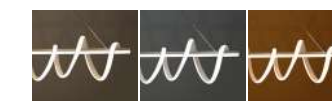
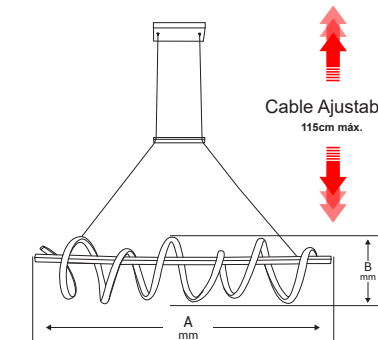

3 EN 1
CAMBIA DE COLOR



ESCANEA
ficha técnica

Dimensiones

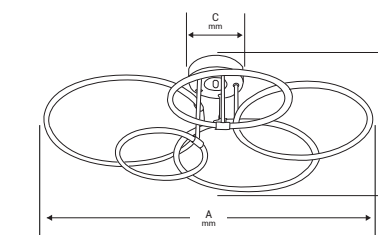

JLAR-8050

Potencia	80W
Tono de Luz	6500 K Luz Fria, 4000 K Luz Neutra, 2700 K Luz Calida
Flujo Luminoso	6 800 lm
Tensión	127V~50/60Hz
Corriente Eléctrica	680mA
Dimensiones	(A) 740mm (B) 740mm (C) Ø150mm





JLAR

Lámpara de techo



JLAR-9001

Potencia	90W
Tono de Luz	
Flujo Luminoso	7 200 lm
Tensión	85-265V~50/60Hz
Corriente Eléctrica	0.77 A
Dimensiones	(A) Ø545mm (B) 130mm

Dimensiones

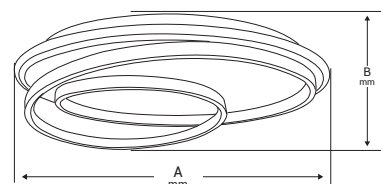

3 EN 1
CAMBIA DE COLOR



ESCANEA
ficha técnica

Dimensiones

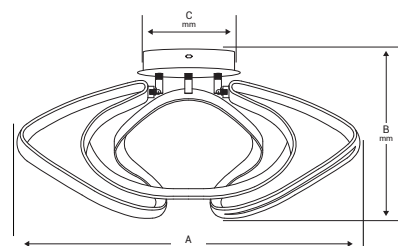

3 EN 1
CAMBIA DE COLOR



JLAR

Lámpara de techo



JLAR-11001

Potencia	110W
Tono de Luz	
Flujo Luminoso	8 800 lm
Tensión	85-265V~50/60Hz
Corriente Eléctrica	0.85 A
Dimensiones	(A) Ø580mm (B) Ø275mm

Dimensiones

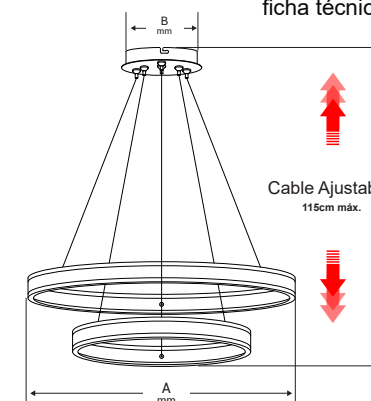

3 EN 1
CAMBIA DE COLOR



ESCANEA
ficha técnica

Dimensiones

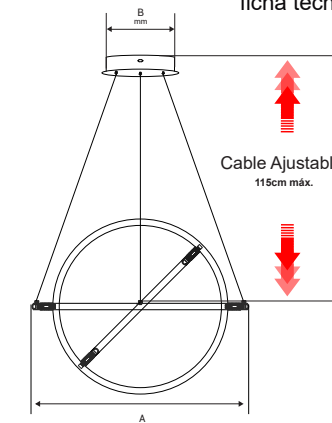

3 EN 1
CAMBIA DE COLOR



JLAR

Lámpara de techo



ESCANEA
ficha técnica

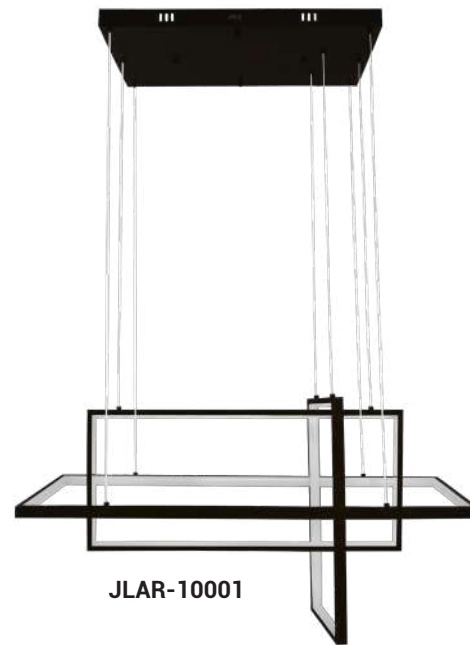

JLAR-10001



JLAR-10002

JLAR-10001 / JLAR-10002

Potencia	100W
Tono de Luz	6500 K Luz Fria 4000 K Luz Neutra 2700 K Luz Calida
Flujo Luminoso	8 000 lm
Tensión	85-265V~50/60Hz
Corriente Eléctrica	0.77 A
Dimensiones	(A) 420mm * 220mm * 20mm (B) 600mm * 260mm * 20mm (C) 800mm * 300mm * 20mm



3 EN 1
CAMBIA DE COLOR

Dimensiones

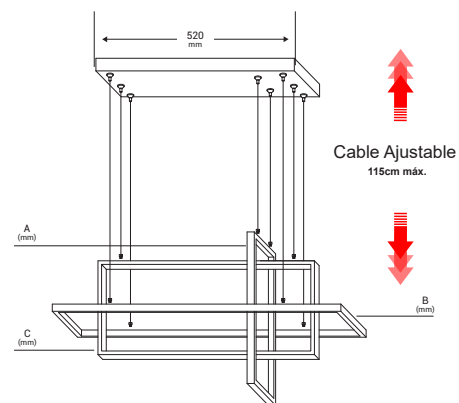

JLC

Lámpara Colgante



ESCANEA
ficha técnica



JLC-N02212

Potencia	50W Máx.
Tensión	127V~50/60Hz
Dimensiones	(A) Ø216mm (B) 850mm (C) Ø100mm
Material	Metal acabado mate

Dimensiones

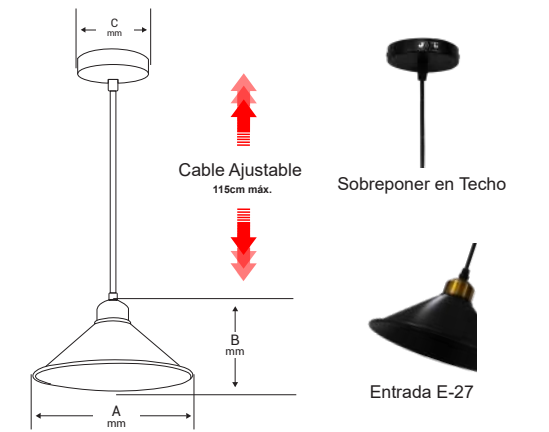

ESCANEA
ficha técnica



JLC-N03522

Potencia	50W Máx.
Tensión	127V~50/60Hz
Dimensiones	(A) Ø350mm (B) 200mm (C) Ø100mm
Material	Metal acabado mate

Dimensiones

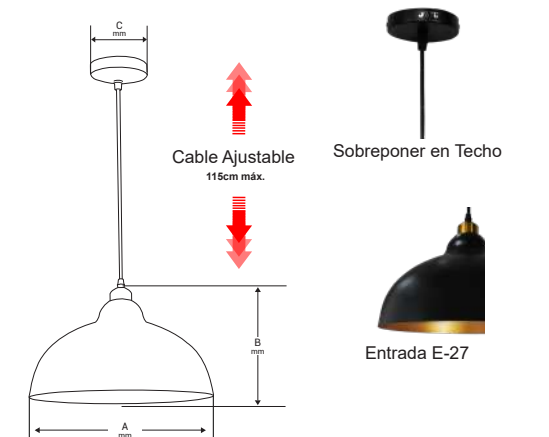



JLC

Lámpara Colgante



ESCANEA
ficha técnica

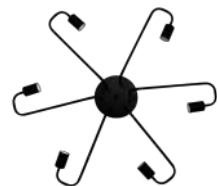

Dimensiones

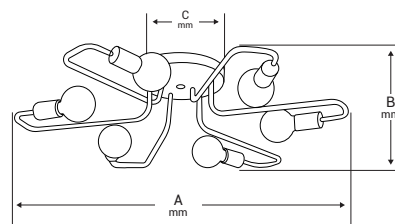

JLC-N06015

Potencia	300W Máx.
Tensión	85-265V~50/60Hz
Dimensiones	(A) 715mm (B) 154mm (C) 178mm
Material	Aluminio Adonizado



ESCANEA
ficha técnica



Dimensiones

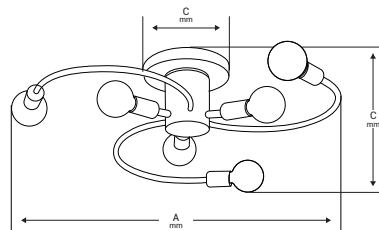

JLC-N06016

Potencia	300W Máx.
Tensión	85-265V~50/60Hz
Dimensiones	(A) 560mm (B) 160mm (C) 148mm
Material	Aluminio Adonizado



JLC

Lámpara Colgante



ESCANEA
ficha técnica



Dimensiones

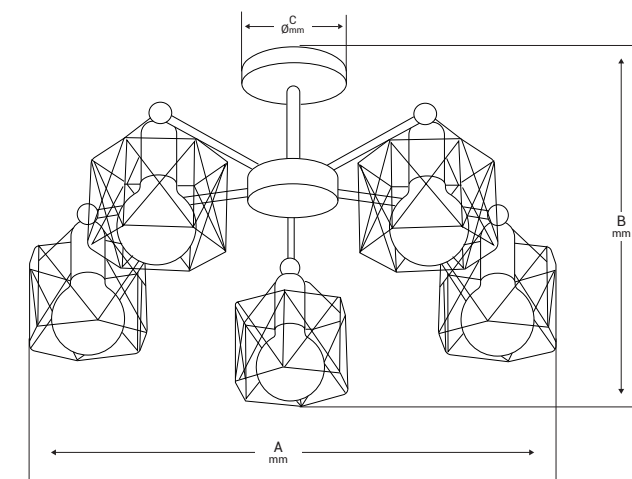

JLC-N07525

Potencia	250W Máx.
Tensión	85-265V~50/60Hz
Dimensiones	(A) 655mm (B) 320mm (C) 150mm
Material	Aluminio Adonizado



Línea Arbotantes de Pared

JPAA

Arbotante de Pared



JPAA-0301

Potencia	3W
Tono de Luz	2700 K Luz Cálida
Flujo Luminoso	270 lm
Tensión	85-265V~50/60Hz
Corriente Eléctrica	24 mA
Dimensiones	(A) 85mm (B) 65mm (C) 45mm



JPAA-0302

Potencia	3W
Tono de Luz	2700 K Luz Cálida
Flujo Luminoso	270 lm
Tensión	85-265V~50/60Hz
Corriente Eléctrica	24 mA
Dimensiones	(A) 85mm (B) 65mm (C) 45mm



ESCANEAR
ficha técnica

Dimensiones

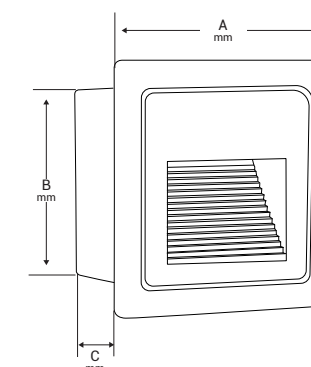

ESCANEAR
ficha técnica

Dimensiones

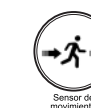
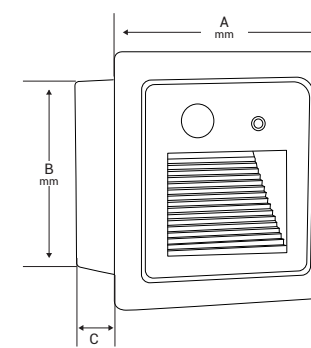

JPAA

Arbotante de Pared



ESCANEA
ficha técnica



JPAA-0303

Potencia	3W
Tono de Luz	2700 K Luz Calida
Flujo Luminoso	270 lm
Tensión	85-265V~50/60Hz
Corriente Eléctrica	24 mA
Dimensiones	(A) Ø84mm (B) 45mm (C) Ø65mm

Dimensiones

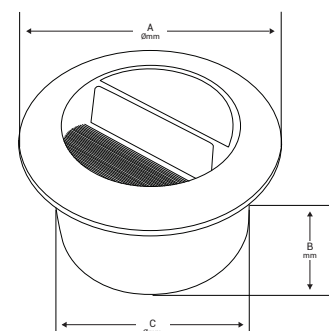

ESCANEA
ficha técnica



JPAA-0304

Potencia	3W
Tono de Luz	2700 K Luz Calida
Flujo Luminoso	270 lm
Tensión	85-265V~50/60Hz
Corriente Eléctrica	24 mA
Dimensiones	(A) 92mm (B) 59mm (C) 45mm

Dimensiones

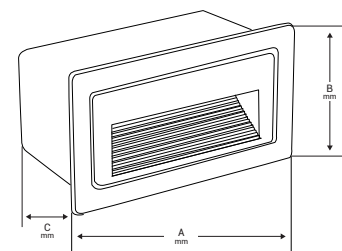

JPAA

Arbotante de Pared



ESCANEA
ficha técnica



JPAA-0306

Potencia	3W
Tono de Luz	2700 K Luz Calida
Flujo Luminoso	165 lm
Tensión	85-265V~50/60Hz
Corriente Eléctrica	24 mA
Dimensiones	(A) 80mm (B) 75mm (C) 63mm

Dimensiones

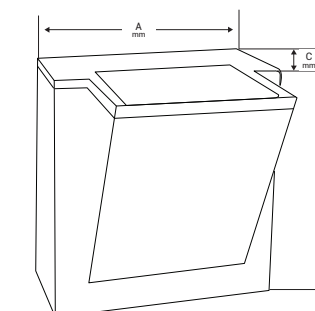

ESCANEA
ficha técnica



JPAA-0401

Potencia	4W
Tono de Luz	2700 K Luz Calida
Flujo Luminoso	220 lm
Tensión	85-265V~50/60Hz
Corriente Eléctrica	31 mA
Dimensiones	(A) 120mm (B) 80mm (C) 40mm

Dimensiones

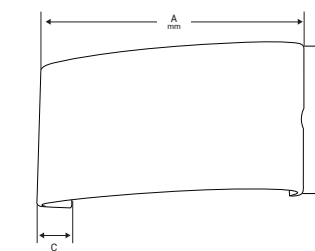

JPAA

Arbotante de Pared



ESCANEA
ficha técnica



JPAA-0407

Potencia	4W
Tono de Luz	2700 K Luz Calida
Flujo Luminoso	220lm
Tensión	85-265V~50/60Hz
Corriente Eléctrica	31 mA
Dimensiones	(A) 163mm (B) 70mm

Dimensiones

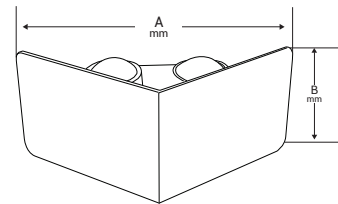

ESCANEA
ficha técnica



JPAA-0408

Potencia	4W
Tono de Luz	2700 K Luz Calida
Flujo Luminoso	360 lm
Tensión	85-265V~50/60Hz
Corriente Eléctrica	31 mA
Dimensiones	(A) 86mm (B) 126mm (C) 32mm

Dimensiones

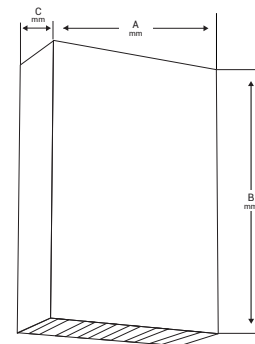

JPAA

Arbotante de Pared



ESCANEA
ficha técnica



JPAA-0409

Potencia	4W
Tono de Luz	2700 K Luz Calida
Flujo Luminoso	220 lm
Tensión	85-265V~50/60Hz
Corriente Eléctrica	31 mA
Dimensiones	(A) 110mm (B) 95mm (C) 44mm

Dimensiones

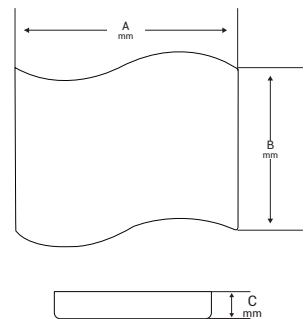

ESCANEA
ficha técnica



JPAA-0512

Potencia	5W
Tono de Luz	2700 K Luz Calida
Flujo Luminoso	275 lm
Tensión	85-265V~50/60Hz
Corriente Eléctrica	39 mA
Dimensiones	(A) 110mm (B) 50mm

Dimensiones

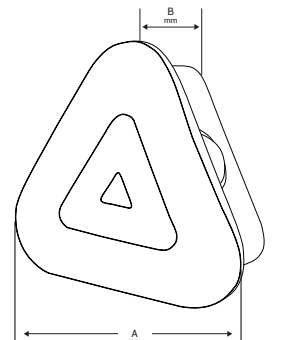

JPAA

Arbotante de Pared



ESCANEAR
ficha técnica



JPAA-0515

Potencia	5W
Tono de Luz	6500 K Luz Fria 4000 K Luz Neutra 2700 K Luz Calida
Flujo Luminoso	450 lm
Tensión	85-265V~50/60Hz
Corriente Eléctrica	39 mA
Dimensiones	(A) 101mm (B) 272mm (C) 42mm

Dimensiones

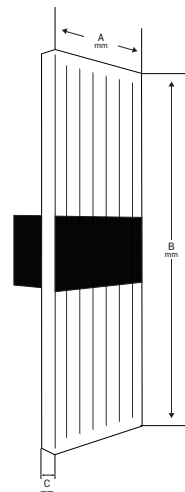

ESCANEAR
ficha técnica



JPAA-0516

Potencia	5W
Tono de Luz	6500 K Luz Fria 4000 K Luz Neutra 2700 K Luz Calida
Flujo Luminoso	450 lm
Tensión	85-265V~50/60Hz
Corriente Eléctrica	39 mA
Dimensiones	(A) 101mm (B) 272mm (C) 42mm

Dimensiones

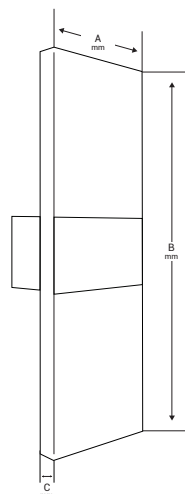

JPAA

Arbotante de Pared



ESCANEAR
ficha técnica



JPAA-0602

Potencia	6W
Tono de Luz	2700 K Luz Calida
Flujo Luminoso	330 lm
Tensión	85-265V~50/60Hz
Corriente Eléctrica	47 mA
Dimensiones	(A) 170mm (B) 80mm (C) 40mm

Dimensiones

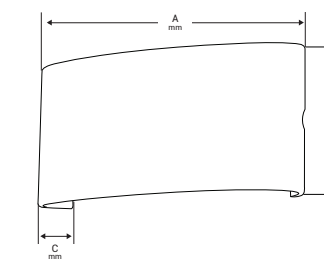

ESCANEAR
ficha técnica



JPAA-0603

Potencia	6W
Tono de Luz	Multicolor RGB
Flujo Luminoso	300 lm
Tensión	85-265V~50/60Hz
Corriente Eléctrica	47 mA
Dimensiones	(A) 170mm (B) 80mm (C) 40mm

Dimensiones

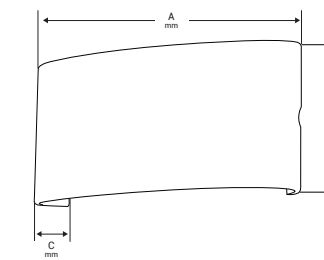

JPAA

Arbotante de Pared



ESCANEA
ficha técnica



Dimensiones

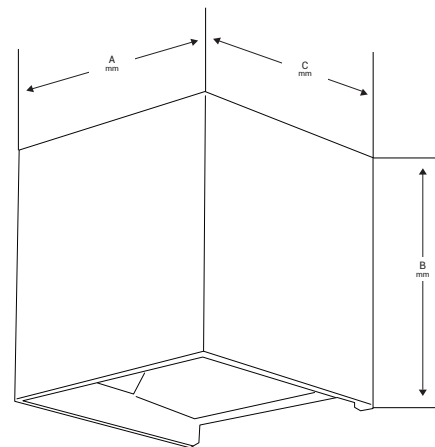

JPAA-0604

Potencia	6W
Tono de Luz	2700 K Luz Calida
Flujo Luminoso	330 lm
Tensión	85-265V~50/60Hz
Corriente Eléctrica	47 mA
Dimensiones	(A) 100mm (B) 100mm (C) 100mm



JPAA

Arbotante de Pared



ESCANEA
ficha técnica



Dimensiones

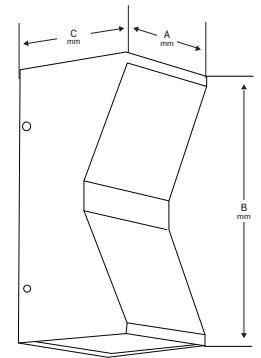

JPAA-0605

Potencia	6W
Tono de Luz	2700 K Luz Calida
Flujo Luminoso	330 lm
Tensión	85-265V~50/60Hz
Corriente Eléctrica	47 mA
Dimensiones	(A) 80mm (B) 141mm (C) 62mm



Dimensiones

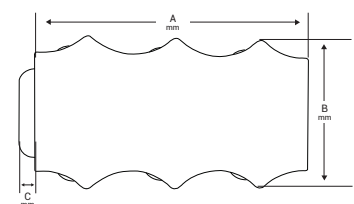

JPAA-0610

Potencia	6W
Tono de Luz	Multicolor
Flujo Luminoso	300 lm
Tensión	85-265V~50/60Hz
Corriente Eléctrica	47 mA
Dimensiones	(A) 158mm (B) 80mm (C) 35mm



Interiores

JPAA

Arbotante de Pared



ESCANEA
ficha técnica



JPAA-0701

Potencia	7W
Tono de Luz	2700 K Luz Calida
Flujo Luminoso	630 lm
Tensión	85-265V~50/60Hz
Corriente Eléctrica	55 mA
Dimensiones	(A) 112mm (B) 157mm (C) 85mm

Dimensiones

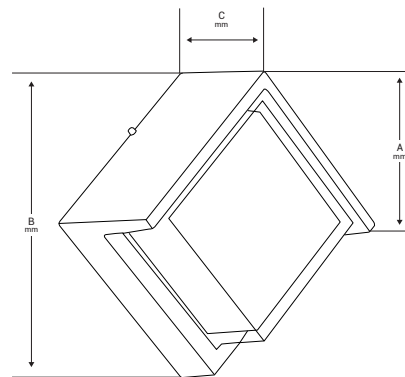

ESCANEA
ficha técnica



JPAA-0702

Potencia	7W
Tono de Luz	2700 K Luz Calida
Flujo Luminoso	630 lm
Tensión	85-265V~50/60Hz
Corriente Eléctrica	55 mA
Dimensiones	(A) 87mm (B) 112mm

Dimensiones

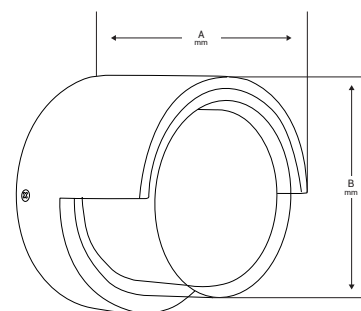

Interiores

JPAA

Arbotante de Pared



ESCANEA
ficha técnica



JPAA-1208

Potencia	12W
Tono de Luz	2700 K Luz Calida
Flujo Luminoso	660 lm
Tensión	85-265V~50/60Hz
Corriente Eléctrica	94 mA
Dimensiones	(A) 68mm (B) 193mm (C) 55mm

Dimensiones

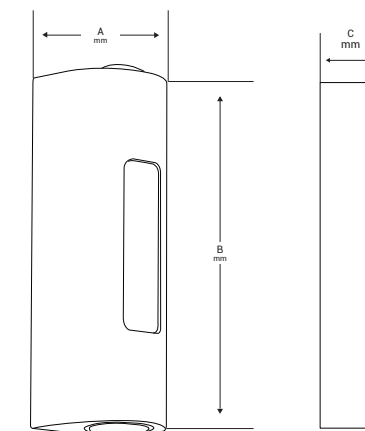

JPAA

Arbotante de Pared



ESCANEA
ficha técnica



JPAA-1411

Potencia	14W
Tono de Luz	2700 K Luz Cálida
Flujo Luminoso	770 lm
Tensión	85-265V~50/60Hz
Corriente Eléctrica	110 mA
Dimensiones	(A) 80mm (B) 140mm

Dimensiones

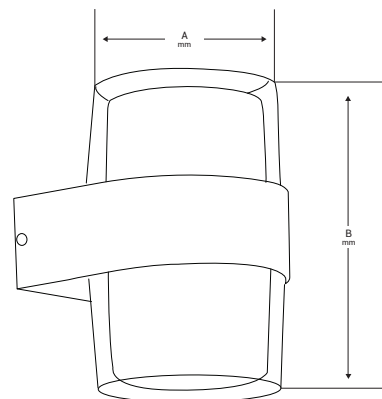

JPAA

Arbotante lineal



ESCANEA
ficha técnica



JPAA-0801

Potencia	8W
Tono de Luz	2700 K Luz Cálida
Flujo Luminoso	720 lm
Tensión	110V~50/60Hz
Corriente Eléctrica	70 mA
Dimensiones	(A) 575mm (B) 55mm (C) 100mm

Dimensiones

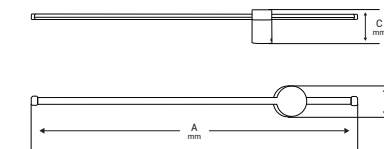

JPAA-1201

Potencia	12W
Tono de Luz	2700 K Luz Cálida
Flujo Luminoso	1080 lm
Tensión	110V~50/60Hz
Corriente Eléctrica	108 mA
Dimensiones	(A) 972mm (B) 55mm (C) 100mm

Dimensiones

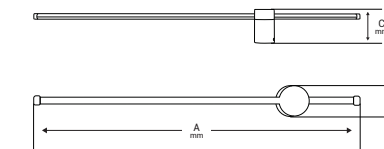



Línea Reflectores

JLRE-C

Reflector led COB alta potencia



ESCANEA
ficha técnica



JLRE-C10

Potencia	10W
Tono de Luz	6500 K Luz Fria
Flujo Luminoso	1 200 lm
Tensión	110-240V~60Hz
Corriente Eléctrica	140mA
Dimensiones	(A) 102mm • (B) 90mm • (C) 35mm



JLRE-C30

Potencia	30W
Tono de Luz	6500 K Luz Fria
Flujo Luminoso	2 700 lm
Tensión	110-240V~60Hz
Corriente Eléctrica	210-460mA
Dimensiones	(A) 178mm • (B) 190mm • (C) 35mm



JLRE-C50

Potencia	50W
Tono de Luz	6500 K Luz Fria
Flujo Luminoso	4 500 lm
Tensión	110-240V~60Hz
Corriente Eléctrica	210-460mA
Dimensiones	(A) 205mm • (B) 215mm • (C) 35mm



JLRE-C100

Potencia	100W
Tono de Luz	6500 K Luz Fria
Flujo Luminoso	9 000 lm
Tensión	110-240V~60Hz
Corriente Eléctrica	0.76-1.43A
Dimensiones	(A) 275mm • (B) 235mm • (C) 35mm



JLRE-C200

Potencia	200W
Tono de Luz	6500 K Luz Fria
Flujo Luminoso	18 000 lm
Tensión	110-240V~60Hz
Corriente Eléctrica	1.53-2.86A
Dimensiones	(A) 390mm • (B) 335mm • (C) 35mm



JLRE-C300

Potencia	300W
Tono de Luz	6500 K Luz Fria
Flujo Luminoso	28 000 lm
Tensión	110-240V~60Hz
Corriente Eléctrica	2.47A
Dimensiones	(A) 450mm • (B) 320mm • (C) 35mm



JLRE-C400

Potencia	400W
Tono de Luz	6500 K Luz Fria
Flujo Luminoso	38 000 lm
Tensión	110-240V~60Hz
Corriente Eléctrica	2.8A
Dimensiones	(A) 500mm • (B) 345mm • (C) 35mm

Dimensiones

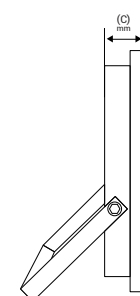
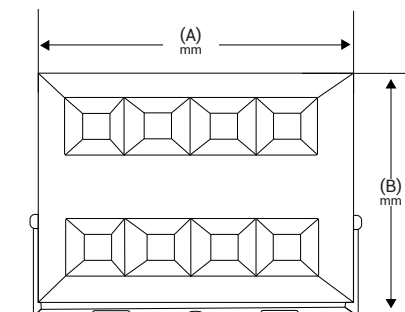

JLRE-P

Reflector led para estadios



ESCANEA
ficha técnica



JLRE-P100

Potencia	100W
Tono de Luz	6500 K Luz Fria
Flujo Luminoso	14 000lm
Tensión	85-265V~50/60Hz
Corriente Eléctrica	800mA
Dimensiones	(A) 355mm • (B) 105mm • (C) 85mm

Dimensiones

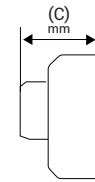
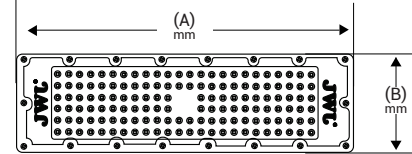

ESCANEA
ficha técnica



JLRE-P200

Potencia	200W
Tono de Luz	6500 K Luz Fria
Flujo Luminoso	28 000 lm
Tensión	85-265V~50/60Hz
Corriente Eléctrica	1.6 A
Dimensiones	(A) 380mm • (B) 245mm • (C) 85mm

Dimensiones

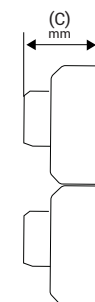
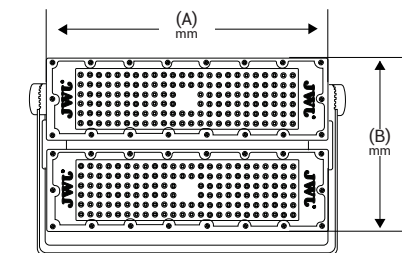

JLRE-P

Reflector led para estadios



ESCANEA
ficha técnica



JLRE-P400

Potencia	400W
Tono de Luz	6500 K Luz Fria
Flujo Luminoso	48 000 lm
Tensión	85-265V~50/60Hz
Corriente Eléctrica	3.30mA
Dimensiones	(A) 363mm • (B) 425mm • (C) 85mm

Dimensiones

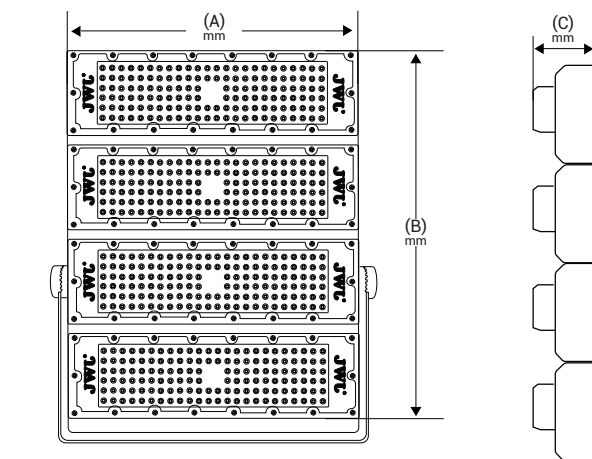

JLRE-L

Reflector led tipo lupa



ESCANEA
ficha técnica



JLRE-L30

Potencia	30W
Tono de Luz	6500 K Luz Fria
Flujo Luminoso	3 000lm
Tensión	110-240V~60Hz
Corriente Eléctrica	136-250mA
Dimensiones	(A) 150mm • (B) 125mm (C) 22mm



JLRE-L50

Potencia	50W
Tono de Luz	6500 K Luz Fria
Flujo Luminoso	5 000 lm
Tensión	110-240V~60Hz
Corriente Eléctrica	210-460mA
Dimensiones	(A) 206mm • (B) 161mm (C) 22mm



JLRE-L100

Potencia	100W
Tono de Luz	6500 K Luz Fria
Flujo Luminoso	10 000 lm
Tensión	110-240V~60Hz
Corriente Eléctrica	0,76-1,43A
Dimensiones	(A) 272mm • (B) 212mm (C) 22mm



JLRE-L200

Potencia	200W
Tono de Luz	6500 K Luz Fria
Flujo Luminoso	20 000lm
Tensión	110-240V~60Hz
Corriente Eléctrica	1,53-2,86mA
Dimensiones	(A) 379mm • (B) 282mm (C) 25mm

Dimensiones

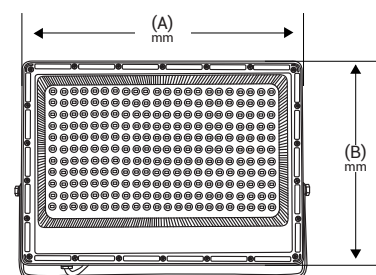

JLRE-T

Reflector tipo lupa



ESCANEA
ficha técnica



JLRE-T30

Potencia	30W
Tono de Luz	6500 K Luz Fria
Flujo Luminoso	3 000lm
Tensión	110-240V~60Hz
Corriente Eléctrica	136-250mA
Dimensiones	(A) 160mm • (B) 140mm (C) 25mm



JLRE-T50

Potencia	50W
Tono de Luz	6500 K Luz Fria
Flujo Luminoso	5 000 lm
Tensión	110-240V~60Hz
Corriente Eléctrica	210-460mA
Dimensiones	(A) 200mm • (B) 174mm (C) 26mm



JLRE-T100

Potencia	100W
Tono de Luz	6500 K Luz Fria
Flujo Luminoso	10 000 lm
Tensión	110-240V~60Hz
Corriente Eléctrica	0,76-1,43A
Dimensiones	(A) 220mm • (B) 255mm (C) 30mm



JLRE-T200

Potencia	200W
Tono de Luz	6500 K Luz Fria
Flujo Luminoso	20 000lm
Tensión	110-240V~60Hz
Corriente Eléctrica	1,53-2,86mA
Dimensiones	(A) 300mm • (B) 345mm (C) 35mm



JLRE-T300

Potencia	300W
Tono de Luz	6500 K Luz Fria
Flujo Luminoso	30 000 lm
Tensión	110-240V~60Hz
Corriente Eléctrica	2,74A
Dimensiones	(A) 325mm • (B) 375mm (C) 35mm

Dimensiones

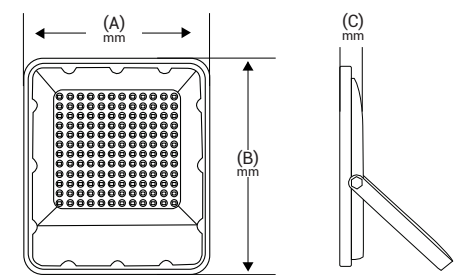

JLRE-E

Reflector led



ESCANEA
ficha técnica



JLRE-E30

Potencia	30W
Tono de Luz	6500 K Luz Fria
Flujo Luminoso	2 400 lm
Tensión	127V~50/60Hz
Corriente Eléctrica	210-460mA
Dimensiones	(A) 145mm • (B) 110mm (C) 30mm



JLRE-E50

Potencia	50W
Tono de Luz	6500 K Luz Fria
Flujo Luminoso	4 000lm
Tensión	127V~50/60Hz
Corriente Eléctrica	210-460mA
Dimensiones	(A) 193mm • (B) 147mm (C) 35



JLRE-E100

Potencia	100W
Tono de Luz	6500 K Luz Fria
Flujo Luminoso	8 000 lm
Tensión	127V~50/60Hz
Corriente Eléctrica	0,76-1,43A
Dimensiones	(A) 255mm • (B) 196mm (C) 37mm



JLRE-E200

Potencia	200W
Tono de Luz	6500 K Luz Fria
Flujo Luminoso	16 000 lm
Tensión	127V~50/60Hz
Corriente Eléctrica	1,53-2,86A
Dimensiones	(A) 370mm • (B) 270mm (C) 40mm



JLRE-E300

Potencia	300W
Tono de Luz	6500 K Luz Fria
Flujo Luminoso	24 000 lm
Tensión	127V~60Hz
Corriente Eléctrica	2,47A
Dimensiones	(A) 427 • (B) 323mm (C) 45mm

Dimensiones

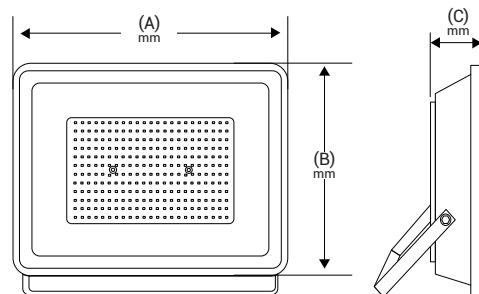

JLRE-N

Reflector multicolor



ESCANEA
ficha técnica



JLRE-10N

Potencia	10W
Tono de Luz	Multicolor RGB
Flujo Luminoso	900 lm
Tensión	85-265V~60Hz
Corriente Eléctrica	45-80mA
Dimensiones	(A) 110mm • (B) 85mm (C) 20mm



JLRE-20N

Potencia	20W
Tono de Luz	Multicolor RGB
Flujo Luminoso	1 800 lm
Tensión	85-265V~60Hz
Corriente Eléctrica	210-460mA
Dimensiones	(A) 118mm • (B) 93mm (C) 25mm



JLRE-30N

Potencia	30W
Tono de Luz	Multicolor RGB
Flujo Luminoso	2 700 lm
Tensión	85-265V~60Hz
Corriente Eléctrica	210-460A
Dimensiones	(A)145mm • (B) 110mm (C) 25mm



JLRE-50N

Potencia	50W
Tono de Luz	Multicolor RGB
Flujo Luminoso	4 500lm
Tensión	85-265V~60Hz
Corriente Eléctrica	210-460mA
Dimensiones	(A) 195mm • (B) 150mm (C) 30mm

Dimensiones

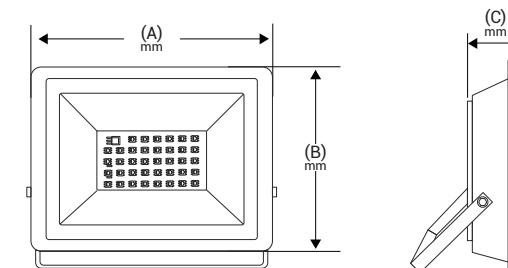



Línea
Solar



JLRE-SOL01

Panel solar con tubo solar



ESCANEA
ficha técnica



JLRE-SOL01-50

Potencia	50W
Tono de Luz	6500 K Luz Fría
Batería	3.7 VDC
Corriente Eléctrica	5 Ah
Dimensiones	(A) 350mm • (B) 226mm (C) 26mm • (D) 16mm



Carga de día

Encendido
automático de noche

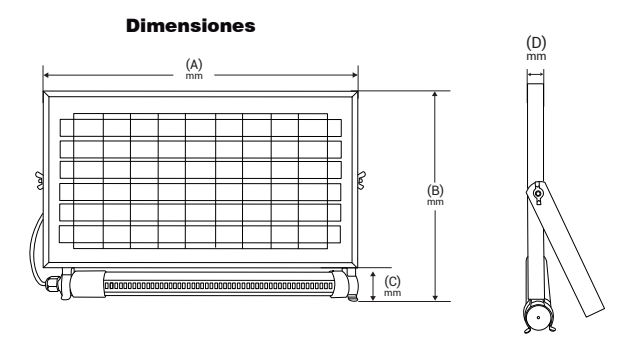

JLRE-SOL01

Reflector led con panel solar



ESCANEA
ficha técnica



JLRE-SOL01-100

Potencia Reflector	100W
Tono de Luz	6500 K Luz Fria
Bateria	3.2 VDC
Potencia de Panel	5V 12W
Corriente Eléctrica	10Ah
Dimensiones Reflector	(A) 180mm • (B) 230mm (C) 50mm
Dimensiones Panel	(A) 290mm • (B) 350mm (C) 16mm



JLRE-SOL01-150

Potencia Reflector	150W
Tono de Luz	6500 K Luz Fria
Bateria	3.2 VDC
Potencia de Panel	5V 15W
Corriente Eléctrica	15Ah
Dimensiones Reflector	(A) 205mm • (B) 260mm (C) 50mm
Dimensiones Panel	(A) 350mm • (B) 350mm (C) 16mm



JLRE-SOL01-200

Potencia Reflector	200W
Tono de Luz	6500 K Luz Fria
Bateria	3.2 VDC
Potencia de Panel	5V 20W
Corriente Eléctrica	20Ah
Dimensiones Reflector	(A) 246mm • (B) 290mm (C) 50mm
Dimensiones Panel	(A) 350mm • (B) 450mm (C) 17mm

Dimensiones

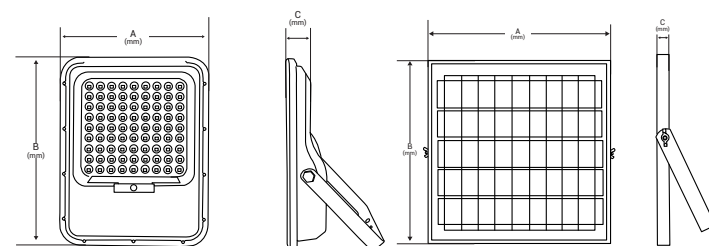

JLRE-SOL01N

Reflector led con panel solar



ESCANEA
ficha técnica



JLRE-SOL01-100N

Potencia Reflector	100W
Tono de Luz	6500 K Luz Fria
Bateria	3.2 VDC
Potencia de Panel	5V 10W
Corriente Eléctrica	12Ah
Dimensiones Reflector	(A) 230mm • (B) 177mm (C) 50mm
Dimensiones Panel	(A) 235mm • (B) 351mm (C) 16mm



JLRE-SOL01-200N

Potencia Reflector	200W
Tono de Luz	6500 K Luz Fria
Bateria	3.2 VDC
Potencia de Panel	5V 15W
Corriente Eléctrica	15Ah
Dimensiones Reflector	(A) 260mm • (B) 200mm (C) 50mm
Dimensiones Panel	(A) 350mm • (B) 350mm (C) 16mm



JLRE-SOL01-300N

Potencia Reflector	300W
Tono de Luz	6500 K Luz Fria
Bateria	3.2 VDC
Potencia de Panel	5V 20W
Corriente Eléctrica	24Ah
Dimensiones Reflector	(A) 290mm • (B) 224mm (C) 50mm
Dimensiones Panel	(A) 351mm • (B) 452mm (C) 16mm

Dimensiones

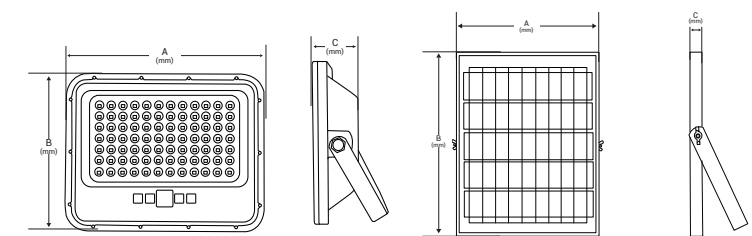

JALP-SOL01

Luminaria pública all in one



ESCANEA
ficha técnica



JALP-SOL01-40

Potencia Reflector	40W
Tono de Luz	6500 K Luz Fria
Flujo luminoso	4 200 lm
Bateria	3.2 VDC
Potencia de Panel	6VDC 6W
Corriente Eléctrica	4Ah
Dimensiones Reflector	(A) 140mm • (B) 400mm (C) 60mm • (D) 50mm



JALP-SOL01-120

Potencia Reflector	120W
Tono de Luz	6500 K Luz Fria
Flujo luminoso	12 500 lm
Bateria	3.2 VDC
Potencia de Panel	6VDC 12W
Corriente Eléctrica	10Ah
Dimensiones Reflector	(A) 190mm • (B) 620mm (C) 60mm • (D) 50mm

Dimensiones

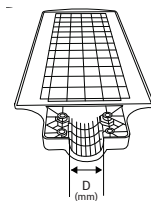
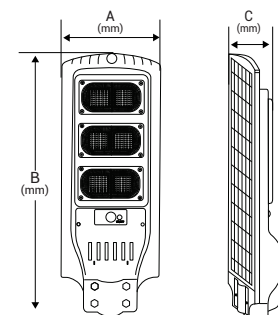

JALP-SOL01-80

Potencia Reflector	80W
Tono de Luz	6500 K Luz Fria
Flujo luminoso	8 200 lm
Bateria	3.2 VDC
Potencia de Panel	6VDC 8W
Corriente Eléctrica	5Ah
Dimensiones Reflector	(A) 185mm • (B) 530mm (C) 60mm • (D) 50mm



JALP-SOL01-160

Potencia Reflector	160W
Tono de Luz	6500 K Luz Fria
Flujo luminoso	15 200 lm
Bateria	3.2 VDC
Potencia de Panel	6VDC 15W
Corriente Eléctrica	15Ah
Dimensiones Reflector	(A) 220mm • (B) 640mm (C) 60mm • (D) 50mm

Accesorios

*No incluidos se vende por separado



JALP-ACC01
Brazo para luminaria
de aluminio

JALP-SOL01-80

Luminaria pública all in one



ESCANEA
ficha técnica



JALP-SOL01-80

Potencia Reflector	80W
Tono de Luz	6500 K Luz Fria
Flujo luminoso	8 200 lm
Bateria	3.2 VDC
Potencia de Panel	6VDC 8W
Corriente Eléctrica	0.22 A
Dimensiones Reflector	(A) 280mm • (B) 617mm (C) 56mm

Dimensiones

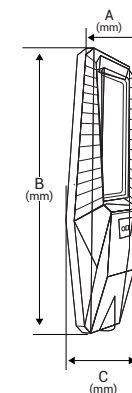

Accesorios



Brazo para luminaria
de aluminio



Exteriores

JLRE-UFO T

Luminaria pública con fotocelda



ESCANEA
ficha técnica



JLRE-UFO100T

Potencia	100W
Tono de Luz	6500 K Luz Fria
Flujo Luminoso	13 000 lm
Tensión	85-265V~50/60Hz
Corriente Eléctrica	455mA
Dimensiones	(A)75mm*(B)53mm* (C)225mm * (D)460mm



Apagado
automático de día



Encendido
automático de noche

Dimensiones

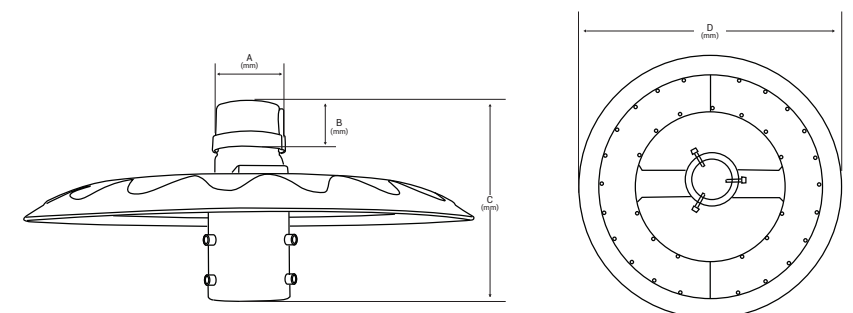

Línea Luminarias Públicas

JALP02-X

Luminaria pública con fotocelda



ESCANEA
ficha técnica



JALP02-50X

Potencia	50W
Tono de Luz	6500 K Luz Fria
Flujo Luminoso	5 000lm
Tensión	100-265V~50/60Hz
Corriente Eléctrica	0.274mA
Dimensiones	(A) 160mm • (B) 390mm (C) 78mm • (D)65mm



JALP02-100X

Potencia	100W
Tono de Luz	6500 K Luz Fria
Flujo Luminoso	10 000 lm
Tensión	100-265V~50/60Hz
Corriente Eléctrica	0.454mA
Dimensiones	(A) 200mm • (B) 465mm (C) 78mm • (D)65mm



JALP02-150X

Potencia	150W
Tono de Luz	6500 K Luz Fria
Flujo Luminoso	15 000 lm
Tensión	100-265V~50/60Hz
Corriente Eléctrica	0.634A
Dimensiones	(A) 215mm • (B) 525mm (C) 78mm • (D)65mm



JALP02-200X

Potencia	200W
Tono de Luz	6500 K Luz Fria
Flujo Luminoso	20 000lm
Tensión	100-265V~50/60Hz
Corriente Eléctrica	0.823mA
Dimensiones	(A) 245mm • (B) 600mm (C) 78mm • (D)65mm

Dimensiones

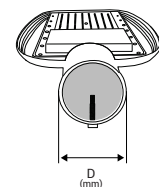
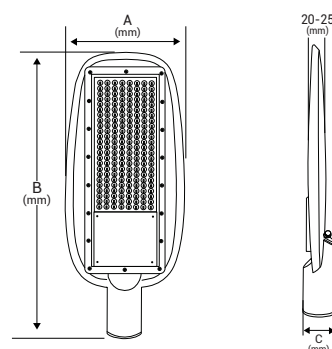

JALP03

Luminaria pública con fotocelda



ESCANEA
ficha técnica



JALP03-100

Potencia	100W
Tono de Luz	6500 K Luz Fria
Tensión	100-265V~50/60Hz
Corriente Eléctrica	0.454A
Dimensiones	(A) 327mm • (B) 500mm (C) 90mm



JALP03-200

Potencia	200W
Tono de Luz	6500 K Luz Fria
Tensión	100-265V~50/60Hz
Corriente Eléctrica	0.823A
Dimensiones	(A) 327mm • (B) 610mm (C) 90mm

Dimensiones

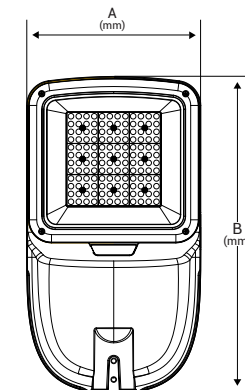

JALP02-S

Luminaria pública con base ajustable



ESCANEA
ficha técnica



JALP02-50S

Potencia	50W
Tono de Luz	6500 K Luz Fría
Flujo Luminoso	5 000lm
Tensión	100-265V~50/60Hz
Corriente Eléctrica	274mA
Dimensiones	(A) 133mm • (B) 460mm (C) 43mm • (D) Ø65



JALP02-100S

Potencia	100W
Tono de Luz	6500 K Luz Fría
Flujo Luminoso	10 000 lm
Tensión	100-265V~50/60Hz
Corriente Eléctrica	454mA
Dimensiones	(A) 150mm • (B) 520mm (C) 43mm • (D) Ø65



JALP02-150S

Potencia	150W
Tono de Luz	6500 K Luz Fría
Flujo Luminoso	15 000 lm
Tensión	100-265V~50/60Hz
Corriente Eléctrica	634mA
Dimensiones	(A) 168mm • (B) 582mm (C) 43mm • (D) Ø65



JALP02-200S

Potencia	200W
Tono de Luz	6500 K Luz Fría
Flujo Luminoso	20 000lm
Tensión	100-265V~50/60Hz
Corriente Eléctrica	823mA
Dimensiones	(A) 197mm • (B) 655mm (C) 43mm • (D) Ø65

Dimensiones

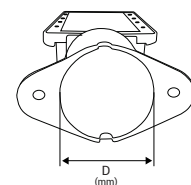
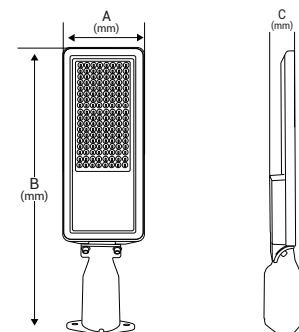

JLMM-20

Lámpara Mata Mosquitos Eléctrico



ESCANEA
ficha técnica



JLMM-20

Potencia	20W
Tono de Luz	Luz Ultravioleta
Tensión	110V~50/60Hz
Dimensiones	(A)455mm (B)253mm
Material	Aluminio

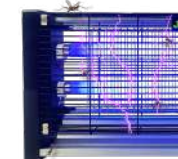

Doble lámpara de 10W

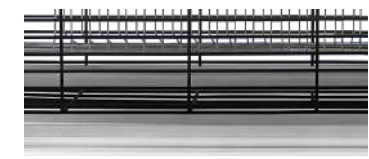

Bandeja para retirar los mosquitos

Dimensiones

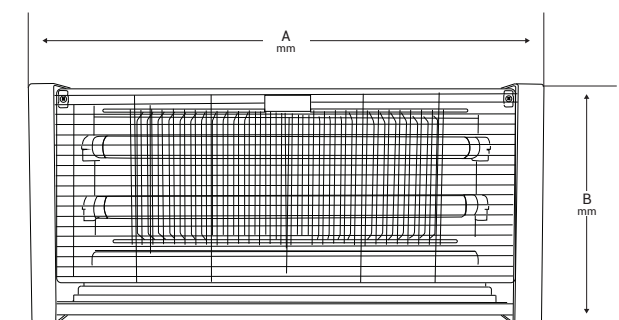

Hasta
90° de Inclinación



Línea Lámpara UFO

JLRE-UFO

Luminario high bay

- 50h
50 000 h
Vida útil
- 90°
Ángulo
de luz
- Instalación
colgar
- No
Dimable



ESCANEA
ficha técnica



JLRE-UFO100

Potencia	100W
Tono de Luz	6500 K Luz Fria
Flujo Luminoso	14 000 lm
Tensión	100-265V~50/60Hz
Corriente Eléctrica	455 mA
Dimensiones	(A) 260mm • (B) 130mm



JLRE-UFO150

Potencia	150W
Tono de Luz	6500 K Luz Fria
Flujo Luminoso	21 000 lm
Tensión	100-265V~50/60Hz
Corriente Eléctrica	680 mA
Dimensiones	(A) 325mm • (B) 140mm



JLRE-UFO200

Potencia	200W
Tono de Luz	6500 K Luz Fria
Flujo Luminoso	28 000 lm
Tensión	100-265V~50/60Hz
Corriente Eléctrica	930 mA
Dimensiones	(A) 500mm • (B) 150mm

Dimensiones

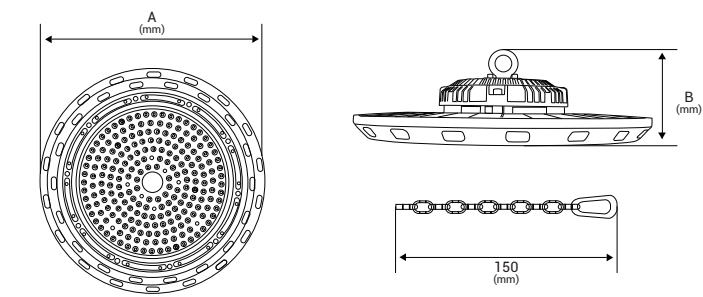

JLRE-UFO-E

Luminario high bay



ESCANEA
ficha técnica

JLRE-UFO100E

Potencia	100W
Tono de Luz	6500 K Luz Fria
Flujo Luminoso	12 000 lm
Tensión	85-265V~50/60Hz
Corriente Eléctrica	455mA
Dimensiones	(A) Ø280mm • (B) 75mm

JLRE-UFO150E

Potencia	150W
Tono de Luz	6500 K Luz Fria
Flujo Luminoso	18 000 lm
Tensión	85-265V~50/60Hz
Corriente Eléctrica	680mA
Dimensiones	(A) Ø310mm • (B) 80mm

JLRE-UFO200E

Potencia	200W
Tono de Luz	6500 K Luz Fria
Flujo Luminoso	24 000lm
Tensión	85-265V~50/60Hz
Corriente Eléctrica	930mA
Dimensiones	(A) Ø340mm • (B) 85mm

Dimensiones

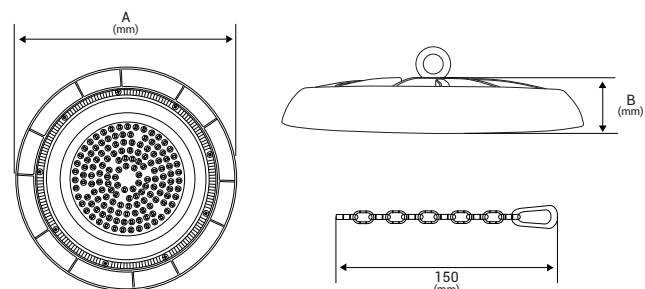

JLRE-UFO-X

Luminario high bay



ESCANEA
ficha técnica

JLRE-UFO100X

Potencia	100W
Tono de Luz	6500 K Luz Fria
Flujo Luminoso	14 000 lm
Tensión	100-265V~50/60Hz
Corriente Eléctrica	455mA
Dimensiones	(A) 290mm • (B) 99mm

JLRE-UFO150X

Potencia	150W
Tono de Luz	6500 K Luz Fria
Flujo Luminoso	21 000 lm
Tensión	100-265V~50/60Hz
Corriente Eléctrica	680mA
Dimensiones	(A) 340mm • (B) 105mm

JLRE-UFO200X

Potencia	200W
Tono de Luz	6500 K Luz Fria
Flujo Luminoso	28 000 lm
Tensión	100-265V~50/60Hz
Corriente Eléctrica	930mA
Dimensiones	(A) 385mm • (B) 109mm

Dimensiones

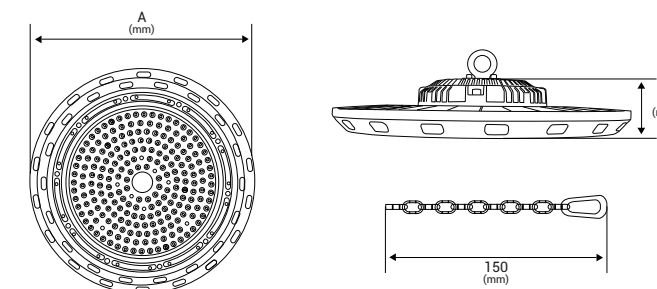



Línea Empotrados de piso

JLLE

Lámpara de piso con estaca



ESCANEA
ficha técnica



JLLE-07

Potencia	7W
Tono de Luz	6500 K Luz Fria 2700 K Luz Calida Luz Verde
Flujo Luminoso	700 lm
Tensión	110-240V~60Hz
Corriente Eléctrica	55mA
Dimensiones	(A) 55mm • (B) 90mm • (C) 108mm



JLLE-09N

Potencia	9W
Tono de Luz	6500 K Luz Fria 2700 K Luz Calida Luz Verde
Flujo Luminoso	900 lm
Tensión	110-240V~60Hz
Corriente Eléctrica	70mA
Dimensiones	(A) 77mm • (B) 100mm • (C) 125mm



JLLE-12N

Potencia	12W
Tono de Luz	6500 K Luz Fria 2700 K Luz Calida Luz Verde
Flujo Luminoso	1 200 lm
Tensión	110-240V~60Hz
Corriente Eléctrica	120mA
Dimensiones	(A) 99mm • (B) 105mm • (C) 133mm

Dimensiones

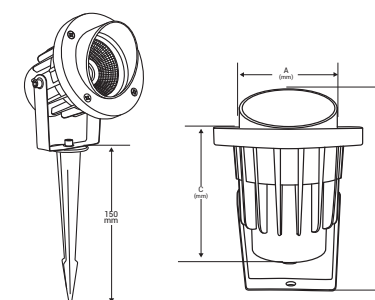

Accesorios

*No incluidos se vende por separado



JLLE07-ACC
Punta / Estaca
Aleación de Aluminio
150 mm.



JLEP

Lámpara de piso empotrable



ESCANEA
ficha técnica



JLEP-0201

Potencia	1.5W
Tono de Luz	2700 K Luz Cálida
Flujo Luminoso	150 lm
Tensión	85-265V~60Hz
Corriente Eléctrica	18mA
Dimensiones	(A) Ø292mm • (B) 53mm • (C) Ø245mm



JLEP-0202

Potencia	1.5W
Tono de Luz	2700 K Luz Cálida
Flujo Luminoso	150 lm
Tensión	85-265V~60Hz
Corriente Eléctrica	18mA
Dimensiones	(A) Ø292mm • (B) 53mm • (C) Ø245mm



JLEP-0204

Potencia	1.5W
Tono de Luz	2700 K Luz Cálida
Flujo Luminoso	150 lm
Tensión	85-265V~60Hz
Corriente Eléctrica	18mA
Dimensiones	(A) Ø292mm • (B) 53mm • (C) Ø245mm

Dimensiones

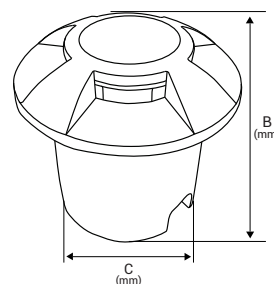
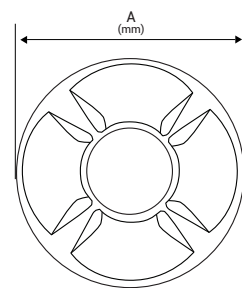

JLEP

Lámpara de piso empotrable



ESCANEA
ficha técnica



JLEP-03

Potencia	3W
Tono de Luz	6500 K Luz Fria / 2700 K Luz Cálida
Flujo Luminoso	360 lm
Tensión	110-240V~60Hz
Corriente Eléctrica	23mA
Dimensiones	(A) Ø80mm • (B) 72mm • (C) Ø65mm



JLEP-05

Potencia	5W
Tono de Luz	6500 K Luz Fria / 2700 K Luz Cálida
Flujo Luminoso	600 lm
Tensión	110-240V~60Hz
Corriente Eléctrica	39mA
Dimensiones	(A) Ø100mm • (B) 82mm • (C) Ø85mm



JLEP-12

Potencia	12W
Tono de Luz	6500 K Luz Fria / 2700 K Luz Cálida
Flujo Luminoso	1 440 lm
Tensión	110-240V~60Hz
Corriente Eléctrica	95mA
Dimensiones	(A) Ø170mm • (B) 92mm • (C) Ø85mm

Dimensiones

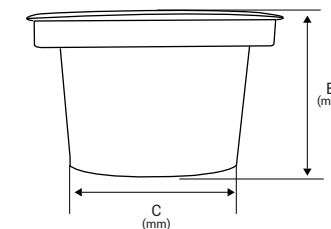
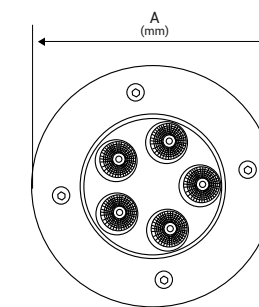

Exteriores

JLEP

Lámpara de piso sobreponer



ESCANEA
ficha técnica



JLEP-03

Potencia	3W
Tono de Luz	2700 K Luz Cálida
Flujo Luminoso	360 lm
Tensión	110-240V~60Hz
Corriente Eléctrica	23mA
Dimensiones	(A) 80mm • (B) 72mm • (C) 65mm

Dimensiones

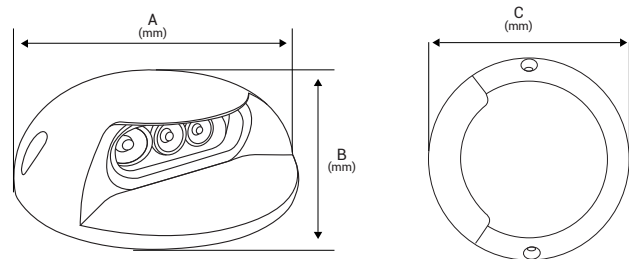

Interiores

JLW

Lámpara led cañon de luz



ESCANEA
ficha técnica



JLW-10

Potencia	10W
Tono de Luz	Blanco Cálido Rojo Azul Verde
Flujo Luminoso	1 200 lm
Tensión	110-240V~60Hz
Corriente Eléctrica	80mA
Dimensiones	(A) 152mm • (B) 72mm •

Dimensiones

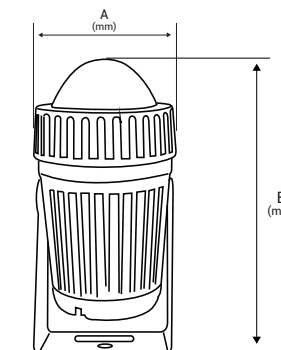

Accesorios

*No incluidos se vende por separado



JLE07-ACC
Punta / Estaca
Aleación de Aluminio
150 mm.



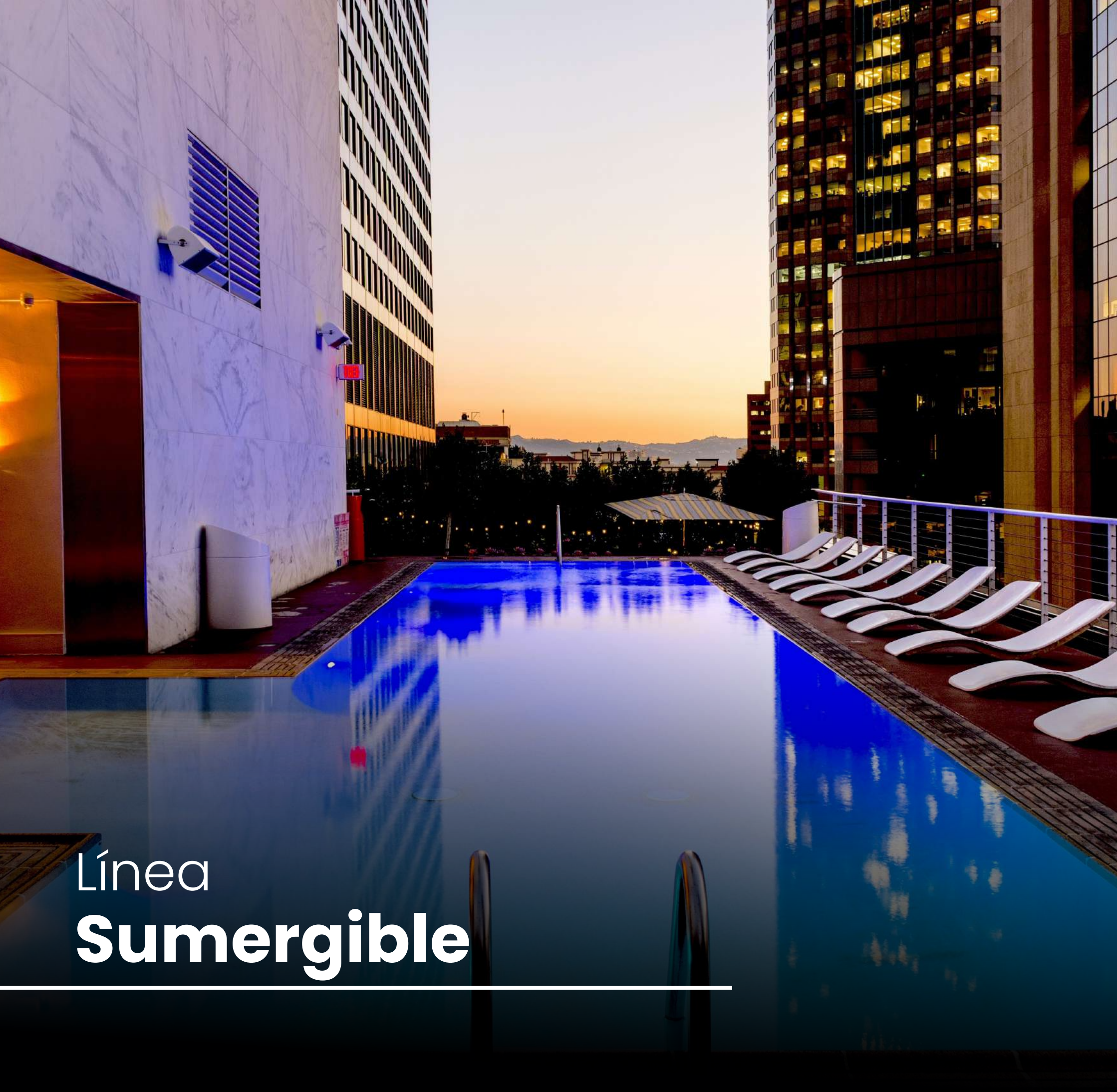

Línea Sumergible

JLSA

Lámpara sumergible

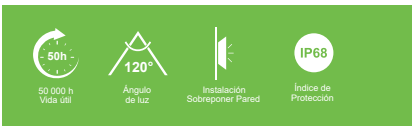

ESCANEA
ficha técnica



JLSA-12A

Potencia	12W
Tono de Luz	6500 K Luz Fria
Flujo Luminoso	1560 lm
Tensión	24V~
Corriente Eléctrica	1mA
Dimensiones	(A) 240mm • (B) 62mm



JLSA-18A

Potencia	18W
Tono de Luz	6500 K Luz Fria
Flujo Luminoso	2 340 lm
Tensión	24V~
Corriente Eléctrica	1.70A
Dimensiones	(A) 290mm • (B) 62mm



JLSA-12A

Potencia	12W
Tono de Luz	Multicolor RGB
Flujo Luminoso	1560 lm
Tensión	24V~
Corriente Eléctrica	1mA
Dimensiones	(A) 240mm • (B) 62mm



JLSA-18A

Potencia	18W
Tono de Luz	Multicolor RGB
Flujo Luminoso	2 340 lm
Tensión	24V~
Corriente Eléctrica	1.70A
Dimensiones	(A) 290mm • (B) 62mm

Dimensiones

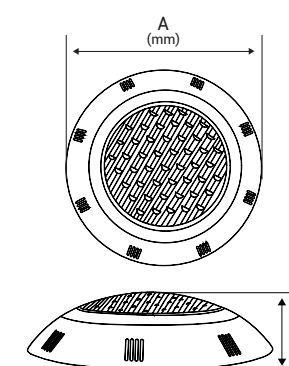

Accesorios

*No incluidos se vende por separado



JPY-20
Transformador
Carga máxima 20W
Para modelos
JLSA-12 y JLSA-18
Conexión máxima 1pz.



JPY-50
Transformador
Carga máxima 50W
Para modelos
JLSA-12
Conexión máxima 3pz.
JLSA-18
Conexión máxima 2pz.



JLS-ACCON-01
Control Remoto
Controla las diferentes
escenas.
Funciona de 30m-50m de
distancia.



Línea Complementos

JMC-06

Multicontacto con Luz Nocturna

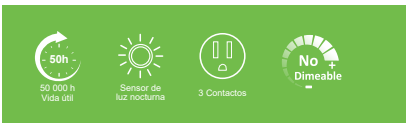

ESCANEA
ficha técnica



JMC-06

Potencia	1W
Tono de Luz	2700 K Luz Calida
Protección	IP20
Tensión	110-240V~60Hz
Corriente Eléctrica	AC 15A 125VAC 1875
Dimensiones	(A) 97mm (B) 75mm (C) 30mm



Botón Manual



Sensor de luz Nocturna

Dimensiones

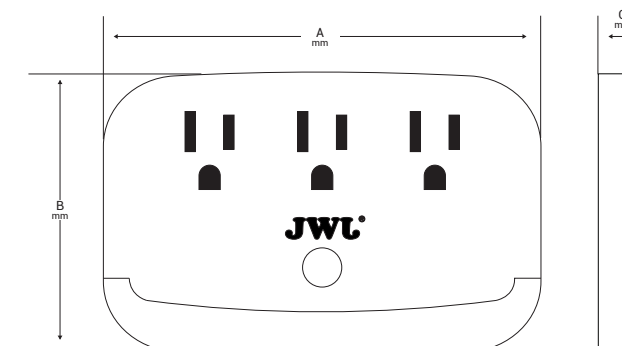

JMC

Barra multicontacto



ESCANEA
ficha técnica



JMC-02

Potencia	1 875W
Calibre de cable	16 AWG
Tensión	125V~60Hz
Corriente Eléctrica	15A / USB 2A
Dimensiones	(A) 298.8 mm • (B) 45mm (C) 34.5mm



JMC-04

Potencia	1 875W
Calibre de cable	16 AWG
Tensión	125V~60Hz
Corriente Eléctrica	15A
Dimensiones	(A) 298.8mm • (B) 45mm (C) 34.5mm



JMC-07

Potencia	1 100W
Calibre de cable	16 AWG
Tensión	127V~60Hz
Corriente Eléctrica	10A
Dimensiones	(A) 255mm • (B) 40mm (C) 29mm

Dimensiones

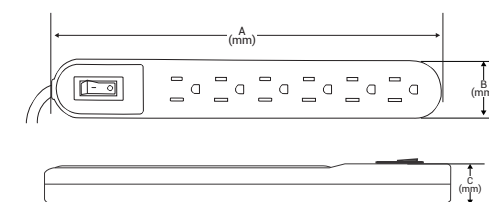

JMC-03

Potencia	1 875W
Calibre de cable	16 AWG
Tensión	125V~60Hz
Corriente Eléctrica	15A / USB 2A
Dimensiones	(A) 256mm • (B) 37mm (C) 30mm



JMC-05

Potencia	1 875W
Calibre de cable	16 AWG
Tensión	125V~60Hz
Corriente Eléctrica	15A
Dimensiones	(A) 256mm • (B) 37mm (C) 30mm



JMC-08

Potencia	1 100W
Calibre de cable	16 AWG
Tensión	127V~60Hz
Corriente Eléctrica	10A
Dimensiones	(A) 245mm • (B) 30mm (C) 24mm



JMC

Extensión eléctrica



ESCANEA
ficha técnica



JMC-09

Potencia	1 625W
Calibre de cable	14 AWG
Tensión	127V~60Hz
Corriente Eléctrica	15A
Dimensiones	5 000mm



JMC-10

Potencia	1 625W
Calibre de cable	14 AWG
Tensión	127V~60Hz
Corriente Eléctrica	15A
Dimensiones	10 000mm



JTL-B

Tomacorrientes

IP20

Índice de Protección



Instalación Sobrepone



ESCANEA
ficha técnica



Placa con interruptor sencillo
JTL-B7201: 10A 127V~60Hz



Placa con 2 interruptores sencillo
JTL-B7205: 10A 127V~60Hz



Placa con 3 interruptores sencillo
JTL-B7209: 10A 127V~60Hz



Placa con botón timbre
JTL-B7213: 10A 127V~60Hz



Placa con toma de corriente 2P+T
JTL-B7222: 15A 127V~60Hz



Placa ciega
JTL-B7245: 10A 127V~60Hz



Placa con 2 toma corriente dúplex 2P+T
JTL-B7224: 15A 127V~60Hz



Placa con toma TV Coaxial
JTL-B7227



Placa con toma telefónica RJ-11 de 4 hilos
JTL-B7228



Placa con dimmer rotativo para lámpara incandescente y/o halógeno
JTL-B7229: 300W 127V~60Hz



Placa con tomacorriente 2P+T y 2 entradas USB tipo A Bambra
JTL-B7270: 127V~60Hz 15A +DC5V/2A



Placa con dimmer rotativo para ventilador
JTL-B7230: 300W 127V~60Hz



Placa con interruptor sencillo
JTL-B7235: 10A 127V~60Hz



Placa con 2 interruptores sencillos
JTL-B7239: 10A 127V~60Hz



Placa con botón timbre
JTL-B7243: 10A 127V~60Hz



Placa con interruptor sencillo y un toma corriente JTL-B7244
10A 127V~60Hz + 15A 127V~60Hz

Placa con interruptor escalera y un toma corriente JTL-B7247
10A 127V~60Hz + 15A 127V~60Hz

Dimensiones

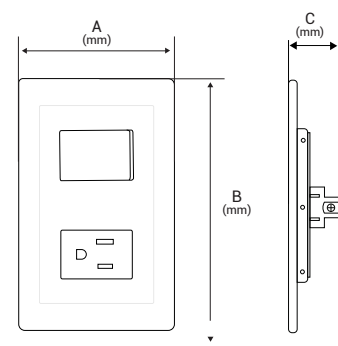

JTL-B

Tensión 127V~60Hz

Corriente Eléctrica 10-15A

Dimensiones (A) 78mm * (B) 118mm * (C) 30mm



JTL-E

Tomacorrientes

IP20

Índice de Protección



Instalación Sobrepone



ESCANEA
ficha técnica



Placa con interruptor sencillo
JTL-E7501: 10A 127V~60Hz



Placa con 2 interruptores sencillo
JTL-E7505: 10A 127V~60Hz



Placa con 3 interruptores sencillo
JTL-E7509: 10A 127V~60Hz



Placa con 1 interruptor sencillo 1 toma corriente
JTL-E7544: 10-15A 127V~60Hz

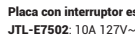

Placa con interruptor escalera
JTL-E7502: 10A 127V~60Hz



Placa con 2 interruptores escalera
JTL-E7506: 10A 127V~60Hz



Placa con 2 toma corriente dúplex 2P+T
JTL-E7524: 10-15A 127V~60Hz



Placa ciega
JTL-E7545: 10A 127V~60Hz



Placa toma TV Coaxial 1 toma corriente
JTL-E7548: 10-15A 127V~60Hz



Placa 2 interruptores sencillos 1 toma corriente
JTL-E7551: 10-15A 127V~60Hz



Placa 1 interruptor sencillos 2 toma corriente
JTL-E7555: 10-15A 127V~60Hz



Placa con botón timbre
JTL-E7513: 15A 127V~60Hz

Dimensiones

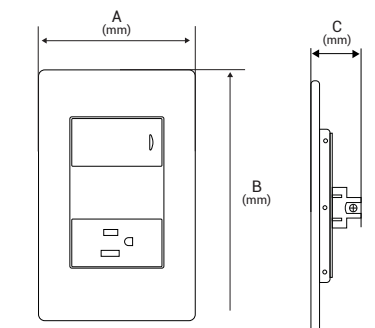

JTL-E

Tensión 127V~60Hz

Corriente Eléctrica 10-15A

Dimensiones (A) 75mm * (B) 122mm * (C) 30mm



JTL-F

Tomacorrientes

IP20

Índice de Protección



Instalación Sobrepone



ESCANEA
ficha técnica



Placa con interruptor sencillo
JTL-F7601: 10A 127V~60Hz



Placa con 2 interruptores sencillo
JTL-F7605: 10A 127V~60Hz



Placa con 3 interruptores sencillo
JTL-F7609: 10A 127V~60Hz



Placa con 1 interruptor sencillo
1 toma corriente
JTL-F7644: 10-15A 127V~60Hz



Placa con 2 toma corriente
dúplex 2P+T
JTL-F7624: 10-15A 127V~60Hz



Placa ciega
JTL-F7645: 10A 127V~60Hz



Placa toma TV Coaxial 1 toma
corriente
JTL-F7648: 10-15A 127V~60Hz



Placa 2 interruptores sencillos 1
toma corriente
JTL-F7651: 10-15A 127V~60Hz



Placa 1 interruptor sencillos 2 toma
corriente
JTL-F7655: 10-15A 127V~60Hz



Placa con botón timbre
JTL-F7613: 15A 127V~60Hz

Dimensiones

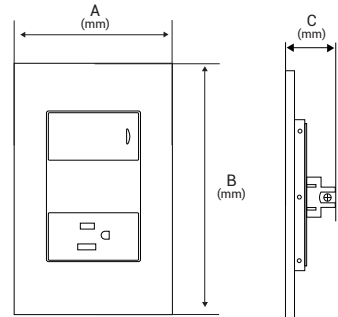

JTL-F

Tensión	127V~60Hz
Corriente Eléctrica	10-15A
Dimensiones	(A) 80mm * (B) 122mm * (C) 30mm



JTL-G

Tomacorrientes

IP20

Índice de Protección



Instalación Sobrepone



ESCANEA
ficha técnica



Placa con interruptor sencillo
JTL-G7701: 10A 127V~60Hz



Placa con 2 interruptores sencillo
JTL-G7705: 10A 127V~60Hz



Placa con 3 interruptores sencillo
JTL-G7709: 10A 127V~60Hz



Placa con interruptor sencillo y un
toma corriente
JTL-G7744: 10A 127V~60Hz

Placa con interruptor escalera
JTL-G7702: 10A 127V~60Hz

Placa con 2 interruptores escalera
JTL-G7706: 10A 127V~60Hz



Placa con 2 toma corriente
dúplex 2P+T
JTL-G7724: 10A/15A 127V~60Hz



Placa ciega
JTL-G7745: 10A 127V~60Hz



Placa con toma TV coaxial y un
tomacorriente
JTL-G7748: 10A/15A 127V~60Hz



Placa con 2 interruptores sencillos
y un toma corriente
JTL-G7751: 10A/15A 127V~60Hz



Placa con 2 toma corrientes y un
interruptor sencillo
JTL-G7755: 10A/15A 127V~60Hz



Placa con botón timbre
JTL-G7713: 10A 127V~60Hz

Dimensiones

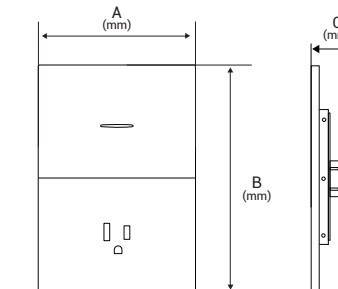

JTL-G

Tensión	127V~60Hz
Corriente Eléctrica	10-15A
Dimensiones	(A) 80mm * (B) 120mm * (C) 34mm





Línea Emergencia

JLMG-10

Reflector de emergencia

50h
50 000 h
Vida útil

Instalación
Sobresimpler

IP66
Índice de
Protección



ESCANEA
ficha técnica



JLMG-10

Potencia	40W
Tono de Luz	6500 K Luz Fria
Flujo Luminoso	500 lm
Tensión	5V
Corriente Eléctrica	2A
Duración de pila	2-3 h
Dimensiones	(A) 127.5mm • (B) 280mm • (C) 56.6mm

Dimensiones

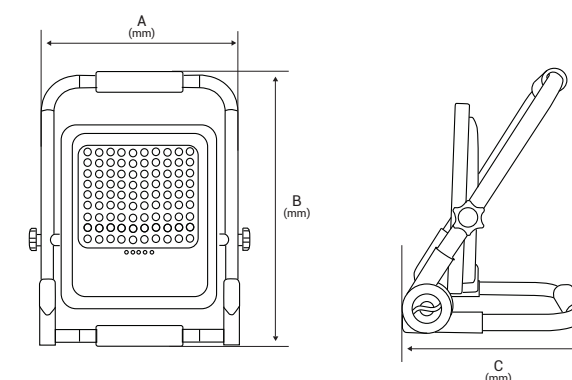

JLMG

Lámparas de Emergencia



ESCAÑEA
ficha técnica



JLMG-01

Potencia	3W
Tono de Luz	2700 K Luz Cálida
Flujo Luminoso	120 lm máx.
Batería	DC 3.7V
Corriente Eléctrica	450 mA
Dimensiones	(A) 200mm (B) 53mm (C) 22mm



JLMG-02

Potencia	3W
Tono de Luz	2700 K Luz Cálida
Flujo Luminoso	300 lm máx.
Batería	DC 3.7V
Corriente Eléctrica	450 mA
Dimensiones	(A) 200mm (B) 65mm (C) 40mm



JLMG-04

Potencia	3.2W
Tono de Luz	2700 K Luz Cálida
Flujo Luminoso	520 lm máx.
Batería	DC 4V
Corriente Eléctrica	700 mA
Dimensiones	(A) 482mm (B) 60mm (C) 45mm

Dimensiones

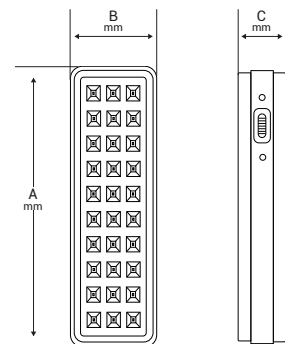

JLMG

Lámparas de Emergencia



ESCAÑEA
ficha técnica



JLMG-05

Potencia	4W
Tono de Luz	2700 K Luz Cálida
Flujo Luminoso	810 lm máx.
Batería	DC 4V
Corriente Eléctrica	700 mA
Dimensiones	(A) 482mm (B) 60mm (C) 45mm



JLMG-06

Potencia	6W
Tono de Luz	2700 K Luz Cálida
Flujo Luminoso	600 lm máx.
Batería	DC 3.7V
Corriente Eléctrica	150 mA
Dimensiones	(A) 250mm (B) 55mm (C) 33mm



JLMG-07

Potencia	4W
Tono de Luz	2700 K Luz Cálida
Flujo Luminoso	810 lm máx.
Batería	DC 4V
Corriente Eléctrica	700 mA
Dimensiones	(A) 355mm (B) 61mm (C) 39mm

Dimensiones

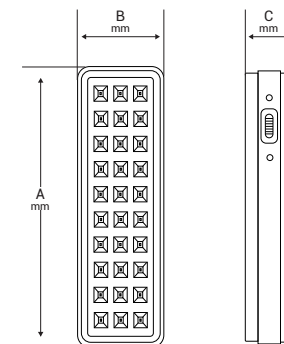



Línea
Industrial

JHEM051892

Cinta de aislar

Instalación
Adherible

IP20
Índice de
Protección



ESCANEA
ficha técnica



JHEM0501892

Acabado	Negro
Material	Plástico (PVC)
Dimensiones	(A) 18mm * (B) 9150mm * (C) 0.19mm

Dimensiones

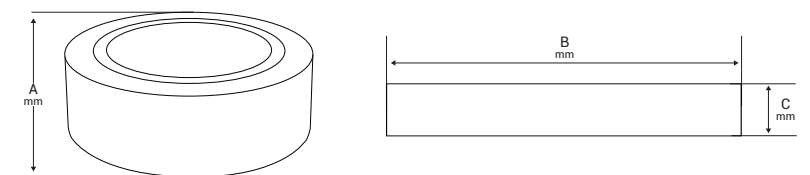

LÁMPARA DE EMERGENCIA



CARACTERISTICAS:

- Ecológica y eficiente con batería de litio
- Material cubierto de Policarbonato(PC) resistente que no se rompe cuando se cae
- Modo de operación no mantenida
- Interruptor de alto y bajo brillo
- Muy luminoso con una luz brillante

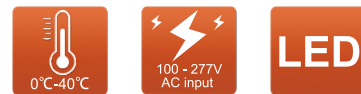

MODELO #	VOLTAJE	EMERGENCIA DE PODER	LUMEN DE EMERGENCIA	BATERIA	Recurso de luz	Material
BY-Z2625A	AC100-277V	4.5W(H)1.5W(L)	500lm(H)140lm(L)	Lithium 3.7V 1.5Ahx3	120pcs SMD2835	ABS+Plating
BY-Z2620A	AC100-277V	4.5W(H)1.5W(L)	500lm(H)140lm(L)	Lithium 3.7V 1.5Ahx3	120pcs SMD2835	ABS
BY-Z2320A	AC100-277V	2W(H)1.5W(L)	260lm(H)120lm(L)	Lithium 3.7V 1.2Ah	60pcs SMD2835	ABS

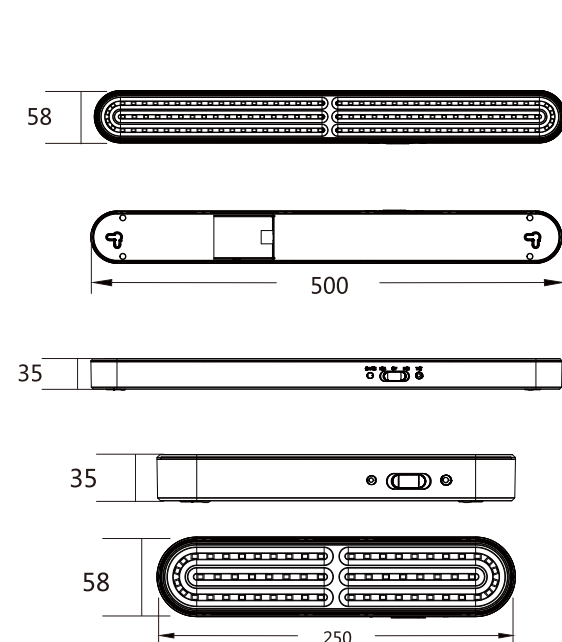

LÁMPARA DE EMERGENCIA



CARACTERISTICAS:

- Ecológica y eficiente con batería de litio
- Material cubierto de Policarbonato(PC) resistente que no se rompe cuando se cae
- Modo de operación no mantenida
- Interruptor de alto y bajo brillo
- Muy luminoso con una luz brillante

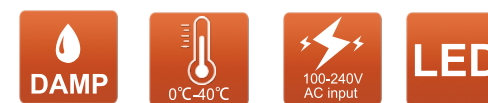

MODELO #	VOLTAJE	EMERGENCIA DE PODER	LUMEN DE EMERGENCIA	BATERIA	Recurso de luz	Material
BY-Z2420A	AC100-240V	1.2W(H)0.6W(L)	160lm(H)90lm(L)	3.7V 1.2Ah	30pcs SMD2835	ABS
BY-Z2425A	AC100-240V	1.2W(H)0.6W(L)	160lm(H)90lm(L)	3.7V 1.2Ah	30pcs SMD2835	ABS+Plating
BY-Z2520A	AC100-240V	0.6W(H)0.4W(L)	65lm(H)45lm(L)	3.7V 1.2Ah	12pcs SMD2835	ABS

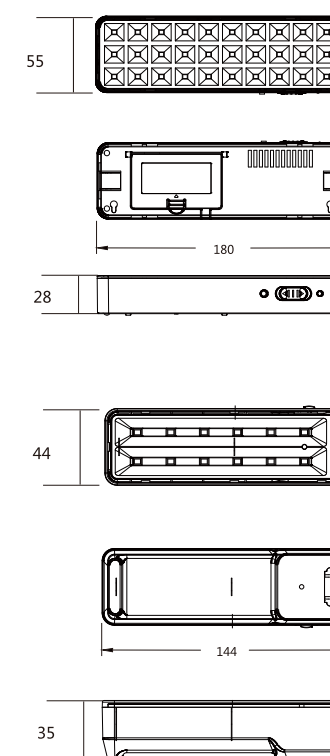

LÁMPARA DE EMERGENCIA



GARANTÍA
3
años

CARACTERÍSTICAS:

- *Instalación Universal: Pared/ Techo/ Instalación como bandera*
- *Iluminación de emergencia de larga duración*
- *Único deslizable riel y con un diseño retractable*
- *Cómodo y con un efecto de brillo con protección de ojos*
- *Reemplazable y con accesorios de montaje rotatable*
- *Modo de operación no mantenido*
- *Material de Policarbonato(PC) para anti-caidas, brillante y fácil de trasladar*
- *Nivel de protección: IP40*



LED

MODELO #	VOLTAJE	EMERGENCIA DE PODER	LUMEN DE EMERGENCIA	BATERIA	Recurso de luz	Material
BY-Z1145A	AC100-240V	3.5W(H)2W(L)	400lm(H)250lm(L)	Lithium 3.7V 1.2Ahx3	102pcs SMD2835	PC
BY-Z1130A	AC100-240V	2.5W(H)1.5W(L)	250lm(H)150lm(L)	Lithium 3.7V 1.2Ahx2	64pcs SMD2835	PC

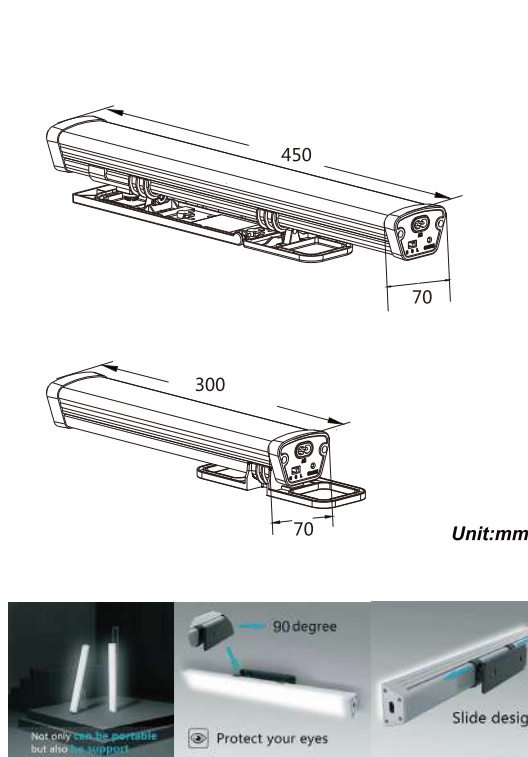

LÁMPARA DE EMERGENCIA DOBLE OJO PUNTO



GARANTÍA
3
años

CARACTERÍSTICAS:

- *Leds de larga duración*
- *Carcasa termoplastica resistente a los rayos UV con clasificación de ANTIFUEGO (UL94 V-0)*
- *Incluye botón de prueba (TEST) e indicador On/Off*
- *Metodos de multi-instalaciones*
- *Cabezas gemelas con angulos ajustables*
- *Facil de abrir sin herramientas*
- *Nuevo material ABS resistente*
- *Dimension pequeña para transporter fácilmente*



LED

MODELO #	VOLTAJE	EMERGENCIA DE PODER	LUMEN DE EMERGENCIA	BATERIA	Recurso de luz	Material
BY-Z3125E	AC120/AC277V	1.6W	100lm	Ni-Cd 3.6V 0.9Ah	2pcs SMD3030	ABS
BY-Z3325E	AC100-240V	1.2W	100lm	Lithium 3.7V 1.5Ah	2pcs SMD3030	ABS

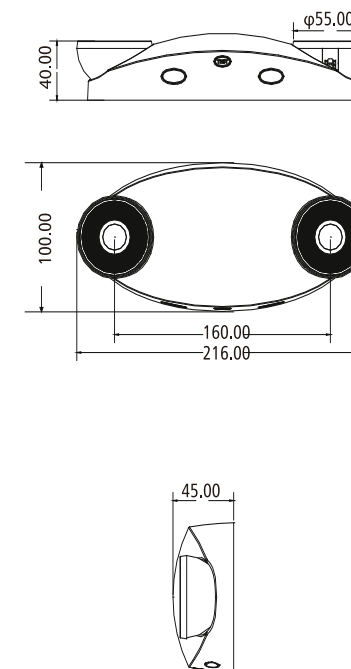

LÁMPARA DE EMERGENCIA



GARANTÍA
3
años

CARACTERISTICAS:

- Ecológica y eficiente con batería de litio
- Material cubierto de Policarbonato(PC) resistente que no se rompe cuando se cae
- Modo de operación no-mantenida
- Interruptor de alto y bajo brillo
- Muy luminoso con una luz brillante



MODELO #	VOLTAJE	EMERGENCIA DE PODER	LUMEN DE EMERGENCIA	BATERIA	Recurso de luz	Material
BY-Z2023A	AC100-277V	3W(H)1.4W(L)	410lm(H)110lm(L)	3.7V 1.2Ahx2	90pcs SMD2835	ABS
BY-Z2025A	AC100-277V	3W(H)1.4W(L)	410lm(H)110lm(L)	3.7V 1.2Ahx2	90pcs SMD2835	ABS+Plating
BY-Z2123A	AC100-277V	3W(H)1.4W(L)	410lm(H)110lm(L)	3.7V 1.2Ahx2	90pcs SMD2835	ABS
BY-Z2125A	AC100-277V	3W(H)1.4W(L)	410lm(H)110lm(L)	3.7V 1.2Ahx2	90pcs SMD2835	ABS+Plating

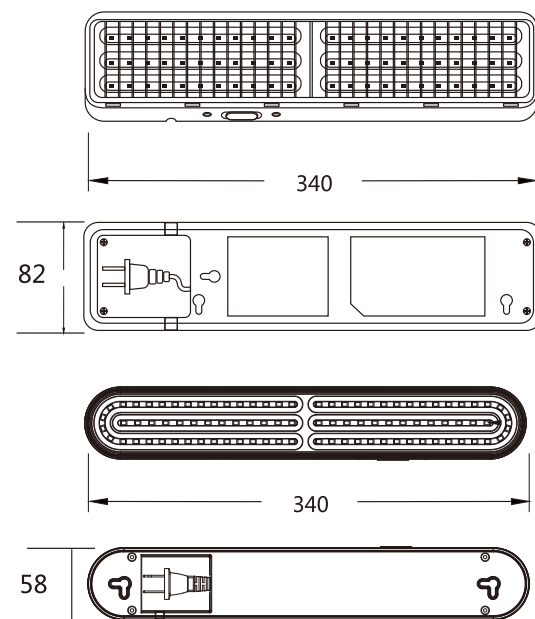

LÁMPARA DE TECHO



GARANTÍA
3
años

CARACTERISTICAS:

- Ecológica y eficiente con batería de litio
- Material cubierto de Policarbonato(PC) resistente que no se rompe cuando se cae
- Modo de operación no mantenida
- Interruptor de alto y bajo brillo
- Muy luminoso con una luz brillante



MODELO #	VOLTAJE	ALIMENTACION AC	EMERGENCIA DE PODER	LUMEN AC	LUMEN DE EMERGENCIA	BATERIA
BY-Z3008E	220-240V	8W	N/A	500lm	N/A	N/A
BY-Z1115E	100-240V	15W	N/A	1250lm	N/A	N/A
BY-Z1118E	100-240V	18W	N/A	1650lm	N/A	N/A
BY-Z1124E	100-240V	24W	N/A	1900lm	N/A	N/A

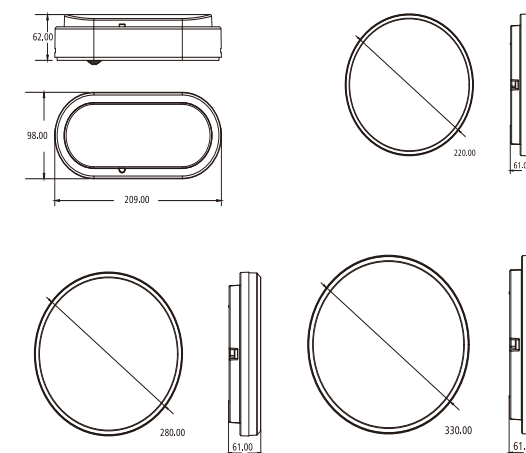

LÁMPARA DE EMERGENCIA DOBLE OJO PUNTO



CARACTERISTICAS:

- Leds de larga duración
- Ecológica y eficiente con batería de litio
- Incluye botón de prueba (TEST) e indicador On/Off
- Nuevo material ABS resistente
- Facil de abrir sin herramientas
- Cabezas gemelas con angulos ajustables:
- Modo de operación mantenida
- Nivel de protección: IP20



MODELO #	VOLTAJE	EMERGENCIA DE PODER	LUMEN DE EMERGENCIA	BATERIA	Recurso de luz	Material
BY-Z3425A	AC100V-240V	1.2W	160lm	18650 3.7V 1.5Ah	24 pcs SMD 2835	ABS
BY-Z4130A	AC100V-240V	1.5W	160lm	18650 3.7V 1.5Ah	24 pcs SMD 2835	ABS
BY-Z4020S	100-240V	2W	220-260lm	3.7V 2.2Ahx2	28pcs SMD LED	ABS+PC

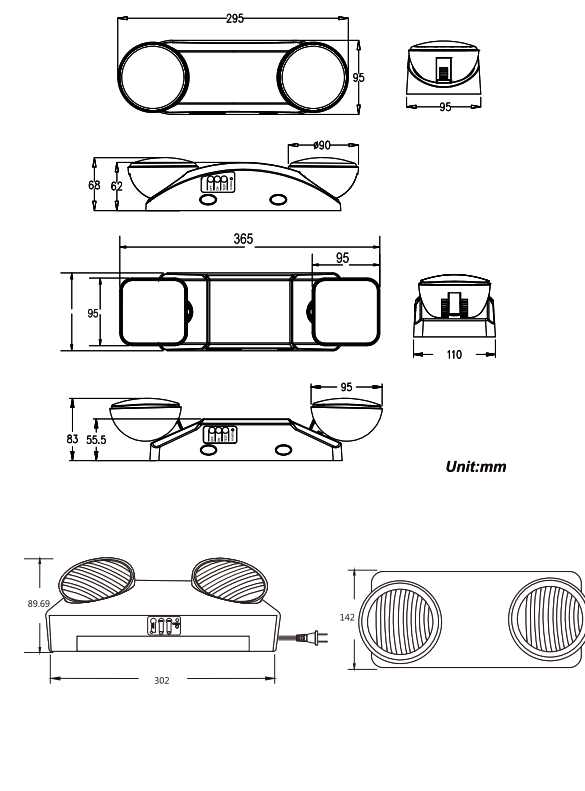

LÁMPARA DE EMERGENCIA DOBLE OJO PUNTO



CARACTERISTICAS:

- Cabezas gemelas con ángulos ajustables
- Lámpara portátil
- Flujo iluminoso de emergencia de 150lm-200lm
- Operación de temperatura: 0C-40C
- Materiales: ABS +PMMA
- Con indicador de carga
- Con indicador de nivel de batería (Alta & Baja)
- Interruptor independiente para cada faro
- Tiempo de emergencia: ≥3horas

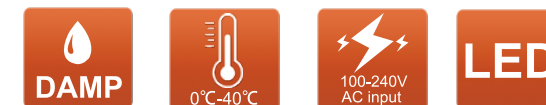

MODELO #	VOLTAJE	EMERGENCIA DE PODER	LUMEN DE EMERGENCIA	BATERIA	Recurso de luz	Material
BY-Z2135C	100-240V	2.0W	180lm	Lithium 3.7V 2.2Ah	32pcs SMD2835	ABS
BY-Z2235C	100-240V	1.8W	180lm	Lithium 3.7V 1.5Ah	32pcs SMD2835	ABS
BY-Z2535C	100-240V	1.5W	180lm	Lithium 3.7V 1.5Ah	14pcs SMD2835	ABS

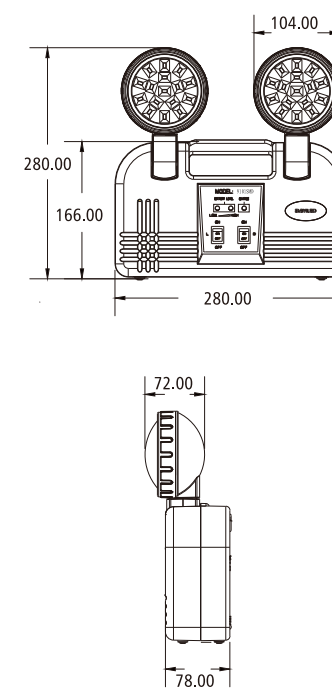

SEÑALIZACIÓN DE EMERGENCIA



GARANTÍA
3
años

CARACTERISTICAS:

- Leds de larga duración
 - Voltaje completo 100V-240V
 - Modo de operación non-mantenida
 - Leyendas adhesivas intercambiables
 - Material: ABS +PC duro
 - Montaje en el techo/ pared/ lateral/ colgado
- Incluye botón de prueba (TEST) e indicador On/Off
Una cara o doble cara
Protección en sobrecarga y sobredescarga



MODELO #	VOLTAJE	EMERGENCIA DE PODER	LUMEN DE EMERGENCIA	BATERIA	Recurso de luz	Material
BY-Z2010A-R/G	AC100-240V	N/A	12lm	Ni-Cd1.2V 0.6Ah	7pcs SMD2835	ABS
BY-Z2110A-R/G	AC100-240V	N/A	12lm	Ni-Cd1.2V 0.6Ah	7pcs SMD2835	ABS



SEÑALIZACIÓN BI-COLOR



GARANTÍA
3
años

CARACTERISTICAS:

- Muy brillante y led de larga duración
- Carcasa termoplástica resistente a los rayos UV con clasificación de ANTIFUEGO (UL94 V-0)
- Incluye botón de prueba (TEST) e indicador AC-On
- Instalación Universal: Pared/ Techo/ Instalación como bandera
- Una cara/ Doble cara
- Incluye toldo accesorio
- Protección en sobrecarga y sobredescarga
- Tiempo de emergencia 90min
- Carcasa blanca o negra



MODELO	VOLTAJE	ALIMENTACION AC	EMERGENCIA DE PODER	LUMEN AC	LUMEN DE EMERGENCIA	BATERIA
BY-F5308U-G	120V/277V	1.2W	0.36W	N/A	N/A	Ni-Cd 1.2V 0.9Ah
BY-F5308U-R	120V/277V	1.2W	0.36W	N/A	N/A	Ni-Cd 1.2V 0.9Ah

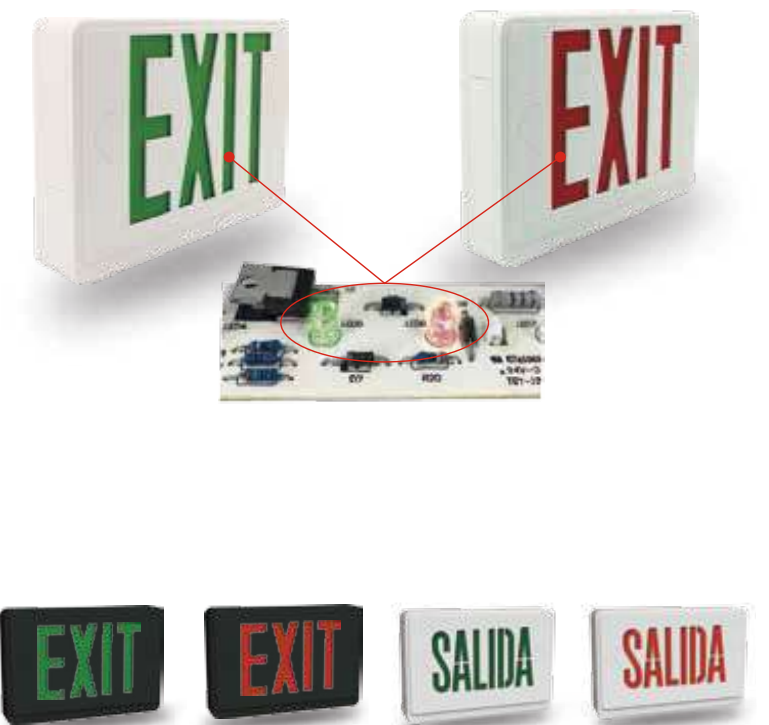
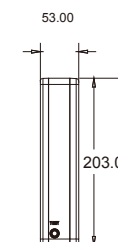
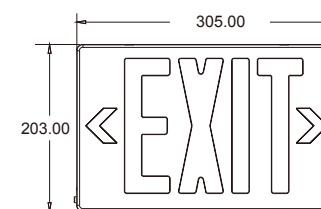

SEÑALIZACIÓN DE SALIDA COMBO



★★★★★
GARANTÍA
3
años

CARACTERISTICAS:

- Muy brillante y led de larga duración
- Carcasa termoplastica resistente a los rayos UV con clasificación de ANTIFUEGO (UL94 V-0)
- Incluye botón de prueba (TEST) e indicador AC-On
- Instalación Universal: Pared/ Techo/ Instalación como bandera
- Una cara/ Doble cara
- Incluye toldo accesorio
- Protección en sobrecarga y sobredescarga
- Tiempo de emergencia 90mins
- Carcasa blanca o negra



MODELO	VOLTAJE	ALIMENTACION AC	EMERGENCIA DE PODER	LUMEN AC	LUMEN DE EMERGENCIA	BATERIA
BY-F5130U-G	120V/277V	3.5W	1.6W	N/A	100lm	Ni-Cd 3.6V 1.2Ah
BY-F5130U-R	120V/277V	3.5W	1.6W	N/A	100lm	Ni-Cd 3.6V 1.2Ah
BY-F5230U-G	120V/277V	3.5W	1.6W	N/A	100lm	Ni-Cd 3.6V 1.2Ah
BY-F5230U-R	120V/277V	3.5W	1.6W	N/A	100lm	Ni-Cd 3.6V 1.2Ah
BY-F5326U-G	120V/277V	3.5W	1.6W	N/A	100lm	Ni-Cd 3.6V 1.2Ah
BY-F5326U-R	120V/277V	3.5W	1.6W	N/A	100lm	Ni-Cd 3.6V 1.2Ah

LÁMPARA DE EMERGENCIA BUCKHEAD



★★★★★
GARANTÍA
3
años

CARACTERISTICAS:

- 3 Horas de iluminación de emergencia
- Múltiples metodos para montaje:
Montaje de techo
Montaje de pared (Accesorios no incluidos)
- Aprobado por certificados CB CE RoHS
- IP65
- Leyendas cambiables



MODELO #	VOLTAJE	ALIMENTACION AC	EMERGENCIA DE PODER	LUMEN AC	LUMEN DE EMERGENCIA	BATERIA
BY-B2310E	220-240V	8.5W	2.0W	400lm	200lm	Ni-Cd SC3.6V 2.0Ah
BY-B2410E	220-240V	8.5W	2.0W	500lm	250lm	Ni-Cd SC3.6V 2.0Ah
BY-B2445E	220-240V	4.5W	2.0W	135lm	135lm	Ni-Cd SC3.6V 1.5Ah
BY-B2445E-T	220-240V	4.5W	2.0W	150lm	150lm	Ni-Cd SC3.6V 1.5Ah

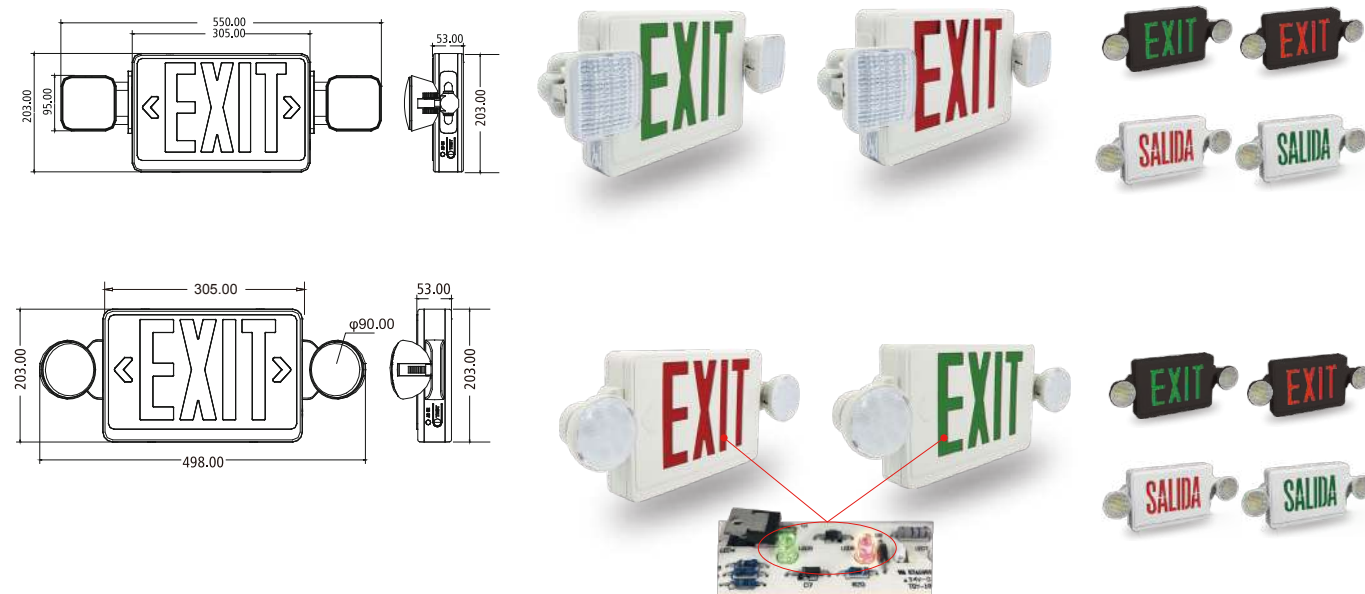
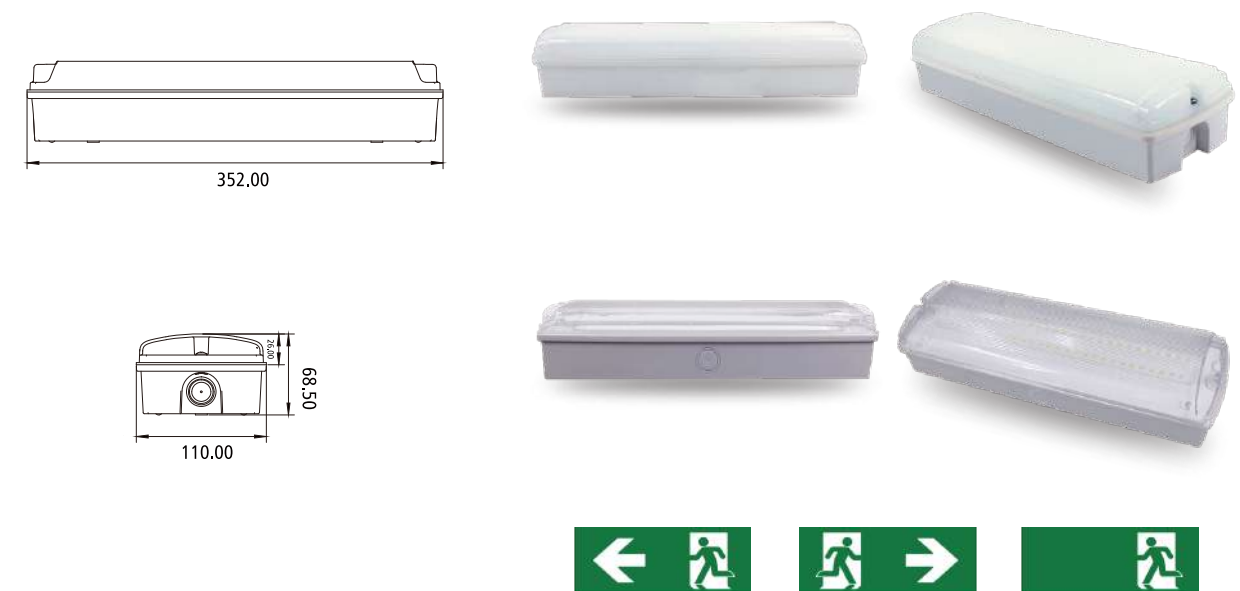

LÁMPARA DE ARMARIO



★★★★★
GARANTÍA
3
años

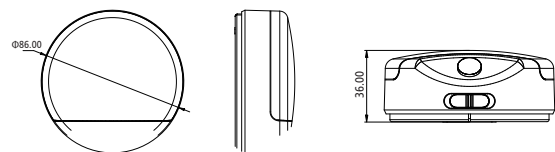

CARACTERÍSTICAS:

Modo: On-Off-Automático
Potencia de salida: 1W
Batería: AA*3
Grado de protección: N/A
LED: 28 piezas SMD 2835
CCT: 5000-6500k
Flujo de luminancia: 100LM
Dimensión(mm): 86.5*36



★★★★★
GARANTÍA
3
años

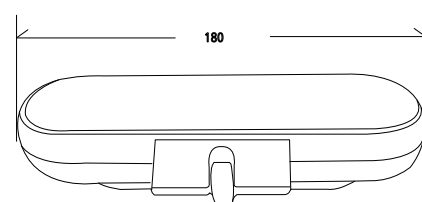

CARACTERÍSTICAS:

Modo: On-Automático-Off
Potencia de salida: 1W
Batería: 18650/3.7V 1200mAh
Grado de protección: N/A
LED: 27 piezas SMD 2835
CCT: 5000-6500k
Flujo de luminancia: 100LM
Dimensión(mm): 180*70*46
Peso: 0.157kg

LÁMPARA DE ARMARIO LÍNEAL



★★★★★
GARANTÍA
3
años

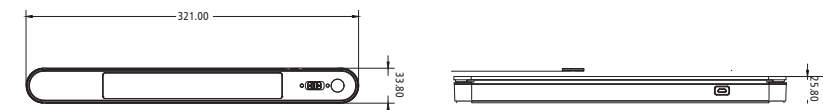

CARACTERÍSTICAS:

Modo: On-Automático-Off
Potencia de salida: 1W
Batería: 14500/ 3.7V 500mAh*2
Grado de protección: N/A
LED: 51 piezas SMD 4014
CCT: 5000-6500k
Flujo de luminancia: 100LM
Dimensión(mm): 321*34*26
Peso: 0.163kg



★★★★★
GARANTÍA
3
años

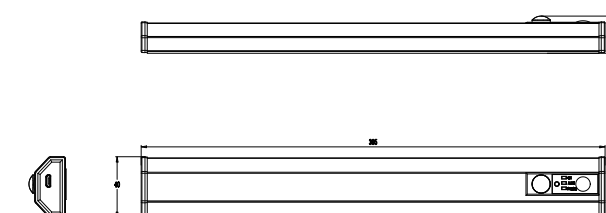

CARACTERÍSTICAS:

Modo: On-Automático-Off
Potencia de salida: 1W
Batería: 14500/ 3.7V 500mAh
Grado de protección: N/A
LED: 25 piezas SMD 2835
CCT: 5000-6500k
Flujo de luminancia: 100LM
Dimensión(mm): 307*38*20
Peso: 0.530kg

LÁMPARA DE CAMPING



GARANTÍA
3
años

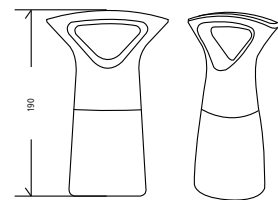

CARACTERISTICAS:

- Modo: Amarillo-Blanco-Destellar-Off
- Potencia de salida: 1W
- Batería: 18650/3.7V 1200mAh
- Grado de protección: N/A
- LED: (2700K)2835*4 (6500K)2835*10
- CCT:5000k-6500k
- Flujo de luminancia: 100LM
- Dimensión(mm): 190*124*72.5
- Peso: 0.110kg

LÁMPARA SOLAR CON SENSOR



GARANTÍA
3
años



CARACTERISTICAS:

- Modo: On-Off/On Automático
- Potencia de salida: 2W
- Batería: 18650/3.7V 1500mAh
- Grado de protección: IP65
- LED: 34 piezas SMD 2835
- CCT: 5000-6500k
- Flujo de luminancia: 200LM
- Dimensión(mm): 159*105*47.5
- Peso: 0.23kg



GARANTÍA
3
años

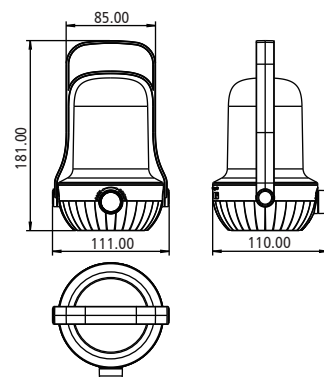

CARACTERISTICAS:

- Modo: Amarillo-Blanco-Amarillo&Blanco
- Potencia de salida: 1W
- Batería: 18650/3.7V 1200mAh*2
- Grado de protección: N/A
- LED: (2700K)2835*6 (6500K)2835*10
- CCT: 2700k 6500k
- Flujo de luminancia: 100LM
- Dimensión(mm): 111*111*180
- Peso: 0.157kg

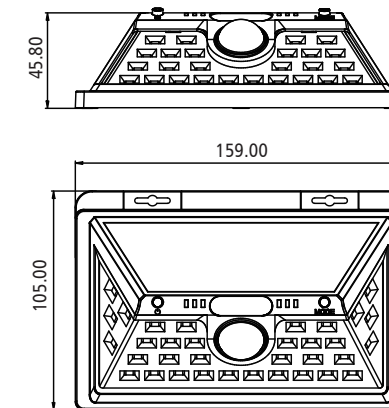

Directorio de tiendas físicas

MATRÍZ

Dr. Lavista 127, Doctores, Cuauhtémoc, 06720 Ciudad de México, CDMX.

- Recepción (55) 5512 4868
- Facturación (55) 2324 4176
- Ventas en línea (55)4345 6035

Lunes a Viernes 09:00-18:00
Sábado 09:00-14:00

CIUDAD DE MÉXICO

IZTAPALAPA

PUNTO DE VENTA
Prof. Javier Rojo Gómez #6, Colonia. El Molino, C.P. 09830, Alc. Iztapalapa, Ciudad de México.

- (55) 5925 5097 (55) 5196 5391
- Lunes a Viernes 10:00-18:00
Sábado 10:00-16:00

CORREGIDORA

PUNTO DE VENTA
Calle Corregidora Josefa O. de Domínguez n.º75 Colonia Centro, Alcaldía Cuauhtémoc C.P. 06060, Ciudad de México.

- (55) 55228340 (55) 5193 0764
- Lunes-Miércoles- Viernes 10:30-18:00
Martes-Jueves 09:00-18:00
Sábado 10:00-16:00

MARROQUÍ 69

PUNTO DE VENTA
Calle José María Marroquí n.º69 Colonia Centro, Alcaldía Cuauhtémoc C.P. 06060, Ciudad de México.

- (55) 5204 5103 (55) 5196 1109
- Lunes a Viernes 10:00-18:00
Sábado 10:00-16:30

MARROQUÍ 81

PUNTO DE VENTA
Calle José María Marroquí n.º81, Local 5 Colonia Centro, Alcaldía Cuauhtémoc C.P. 06000, Ciudad de México.

- (55) 5510 3444
- Lunes a Viernes 10:00-18:00
Sábado 10:00-16:30

LÓPEZ 27

TIENDA EXCLUSIVA
Calle López n.º27 Local 1, Colonia Centro, Alcaldía Cuauhtémoc C.P. 06070, Ciudad de México.

- (55) 5512 0784 / (55) 6468 5264
- Lunes a Viernes 09:30-19:00
Sábado 09:30-17:00

LÓPEZ 39

PUNTO DE VENTA
Calle López n.º39 Local F, Colonia Centro, Alcaldía Cuauhtémoc C.P. 06050, Ciudad de México.

- (55) 5801 9906 (55) 4579 9041
- Lunes a Viernes 09:00-16:00
Sábado 10:00-17:00

LÓPEZ 43

PUNTO DE VENTA
Calle López n.º43, Local A2-A3 Colonia Centro, Alcaldía Cuauhtémoc C.P. 06000, Ciudad de México.

- (55) 2121 0067 (55) 5194 2422
- Lunes a Viernes 10:00-19:00
Sábado 10:00-16:00

ARGENTINA

PUNTO DE VENTA
Calle República de Argentina n.º39-A, Local A Colonia Centro, Alcaldía Cuauhtémoc C.P. 06000, Ciudad de México.

- (55) 2616 4377
- Lunes a Sábado 09:45-17:45

LUIS MOYA

PUNTO DE VENTA
Calle Luis Moya n.º64, Local 2 Planta Baja Colonia Centro Alcaldía Cuauhtémoc C.P. 06000, Ciudad de México.

- (55) 5131 4621 (55) 5158 1447
- Lunes a Viernes 09:00-18:00
Sábado 09:00-17:00

VICTORIA 6

TIENDA EXCLUSIVA
Calle Victoria n.º8, Local B Colonia Centro, Alcaldía Cuauhtémoc C.P. 06050, Ciudad de México.

- (55) 5521 5533
- Lunes a Sábado 09:30-18:30

VICTORIA 8

TIENDA EXCLUSIVA
Victoria 6 Loc. C, Centro (Alameda) C.P. 06050, Cuauhtémoc, CDMX.

- (55) 5518 1427
- Lunes a Sábado 09:30-18:30

VICTORIA 12

TIENDA EXCLUSIVA
Victoria #12 local 1, Col. centro C.P. 06070, Alc. cuauhtemoc, CDMX.

- (55) 5518 7100 / (55) 4607 3162

CASAS ALEMÁN

TIENDA EXCLUSIVA
Calle Puerto Acapulco n.º18, Local B Col. Ampliación Casas Alemán, Alcaldía GAM C.P. 07580, Ciudad de México.

- (55) 5750 5919 (55) 5192 4012
- Lunes a Viernes 10:30-18:30
Sábado 10:00-18:00

PLAZA DE LA ILUMINACIÓN

TIENDA EXCLUSIVA
Calle Victoria n.º12, Local 2 Colonia Centro, Alcaldía Cuauhtémoc C.P. 06000, Ciudad de México.

- (55) 5750 5919 (55) 5192 4012
- Lunes a Sábado 10:00-19:00

ESTADO DE MÉXICO

CUATITLÁN

PUNTO DE VENTA
C. Carrillo Puerto número 104, local B, Colonia Centro, 54800 Cuautitlán, Estado de México.

- (55) 5996 9597
- Lunes a Viernes 10:00-16:30
Sábado 10:00-16:00

CHALCO

PUNTO DE VENTA
Av. Chalma S/N Mz 20 Lt 3, Local 2, Arcos de la Hacienda, C.P. Cuautitlán Izcalli, Méx.

- (55) 9135 6498
- Lunes a Viernes 10:00-18:00
Sábado 10:00-16:00

- (55) 5518 7100 / (55) 4607 3162

CHALCO

PUNTO DE VENTA
María Morelos 1, La Conchita, 56600 Chalco de Díaz Covarrubias, Méx.

- (55) 5975 4116 (55) 5193 2185
- Lunes a Sábado 10:00-18:00

NEZAHUALCÓYOTL

PUNTO DE VENTA
Av. Adolfo López Mateos n.º387, Colonia Ampliación Evolución, C.P. 57700 Municipio de Nezahualcóyotl, Edo. Mex.

- (55) 1334 2383 (55) 1241 1722
- Lunes a Viernes 10:00-18:00
Sábado 10:00-15:00

ECATEPEC

PUNTO DE VENTA
Av. Via Morelos, Mz 1, Lt 16, Colonia Nuevo Laredo C.P. 55080, Municipio de Ecatepec de Morelos, Edo. Mex.

- (55) 25806702 (55) 5196 4598
- Lunes a Viernes 10:00-18:00
Sábado 10:00-15:00

COACALCO

TIENDA EXCLUSIVA
Cerrada de La Paz No. 1 Local A y B con Esq. Av. López Portillo No. 2, Col. Coacalco Centro en Coacalco de Berriozábal, C.P. 55700, Edo. Mex.

- (55) 5801 4363
- Lunes a Viernes 10:00-18:00
Sábado 10:00-16:00

INTERIOR DE LA REPÚBLICA

PUEBLA

PUNTO DE VENTA
C. 18 Sur 3102, Mirador, Heroica Puebla de Zaragoza, Pue. C.P. 72530.

- (222) 760 0931
- Lunes a Viernes 09:00-18:00
Sábado 10:00-16:00

PUNTO DE VENTA
Galería Las Animas, Local 7 y 8, C.P. 72400, Heroica de Puebla Zaragoza, Pue.

- (222) 760 0931
- Lunes a Viernes 09:00-18:00
Sábado 10:00-16:00

TLAXCALA

TIENDA EXCLUSIVA
Privada Manuel García Méndez n.º503 Local A Colonia Centro, C.P. 90300, Apizaco Tlaxcala

- (241) 113 0498
- Lunes a Viernes 09:30-20:00

GUANAJUATO

TIENDA EXCLUSIVA
Bld. Miguel Hidalgo n.º1826 Colonia San Jeronimo I, C.P. 37204, León Guanajuato.

- (477) 718 1412
- Lunes a Viernes 10:00-19:00
Sábado 09:00-14:00

PUNTO DE VENTA
Bld. Miguel Hidalgo n.º901-C, Colonia Los Reyes, C.P. 37190, León Guanajuato.

- (55) 5522 8340
- Lunes a Sábado 09:30-18:30

QUERÉTARO

PUNTO DE VENTA
Monte Alban n.º214 , Colonia Valle Alameda, C.P. 76040, Querétaro, Querétaro.

- (442) 214 5564
- Lunes a Viernes 09:00-19:00
Sábado 09:00-15:00

PACHUCA

TIENDA EXCLUSIVA
Bld. Felipe Angeles n.º1964 Loc. G, Col. Ampliación Santa Julia , C.P. 42080, Pachuca de Soto, HGO.

- (771) 714 4110
- Lunes a Viernes 09:00-18:00
Sábado 09:00-14:00

OAXACA

TIENDA EXCLUSIVA ILUMA
Mier y teran #511, col.centro, C.P. 68000, Caxaca, oax.

- (951) 514 3906 / (951) 516 5083
- Lunes a Viernes 09:00-18:30
Sábado 09:00-16:30

GUADALAJARA

PUNTO DE VENTA
Av. Cristóbal Colón n.º827, Colonia Moderna C.P. 44190, Guadalajara Jalisco.

- (333) 658 1111
- Lunes a Sábado 10:00-18:30

PUNTO DE VENTA
Av. Plaza del Sol n.º289, Colonia Rinconada del sol C.P. 45050, Zapopan Jalisco.

- (33)31230183
- Lunes a Viernes 09:00-19:00
Sábado 09:00-15:00

CULIACÁN, SINALOA

TIENDA EXCLUSIVA
Av. Nicolás Bravo n.º120-A Col. Jorge Almada C.P. 80200, Culiacán Sinaloa.

- (667) 258 5669 (667) 307 9961
- Lunes a Viernes 09:00-18:00
Sábado 09:00-14:00

PUNTO DE VENTA
Bld. Francisco I. Madero n.º1557-B, Col. Hidalgo C.P. 80090, Culiacán, Sinaloa.

- (667) 455 8732 (667) 784 6150
- Lunes a Viernes 09:00-18:00
Sábado 09:00-14:00

PUNTO DE VENTA
Av. Bicentenario Juárez 6, Francisco Villa, 82127 Mazatlán, Sin.

- (669) 193 1355 (667) 446 0157
- Lunes a Sábado 09:45-17:45

TIENDA EXCLUSIVA
Juarez #37 Ote, Colonia Centro, C.P. 81200, Los Mochis Ahome, Sinaloa.

- (668) 176 8949 (668) 250 5023

TIENDA EXCLUSIVA
Juan carrasco #523-b, Col. Centro C.P. 82000, Mazatlán, Sinaloa.

- (668) 193 1355

VERACRUZ

TIENDA EXCLUSIVA
Bld A. Ruiz Cortines Esq.10 Oriente. Colonia Obrera, C.P. 93260, Poza Rica Veracruz.

- (782) 823 7350
- Lunes a Sábado 09:00-20:30
Domingo 10:00-15:00

TIENDA EXCLUSIVA
Av. Salvador Diaz Mirón n.º1309 Esq. Manlio Fabio Altamirano, Col. Centro C.P. 91700, Veracruz Veracruz.

- (22)99 32 84 73
- Lunes a Sábado 09:30-20:30
Domingo 10:00-15:00

CAMPECHE

TIENDA EXCLUSIVA
Av. Adolfo López Mateos no 145 entre Allende y Aldama, Colonia 24040, C.P. 24020, Campeche, Campeche.

- (98) 1823 6539
- Lunes a Martes 09:30-18:30
Miércoles a Viernes 09:00-19:00
Sábado 09:00-16:00

MÉRIDA

COMERCIALIZADORA
Av. Itzaes n.º631 B, entre calles 94 y 96, Col. Nueva Sumbula C.P. 97250, Mérida Yucatán.

- (999) 287 1111 / (999)176 6060
- Lunes a Viernes 09:30-18:30
Sábado 09:30-16:00

QUINTANA ROO

PUNTO DE VENTA
SM. 31, Mz.6 LT.22, Supermanzana n.º31 Cancún Quintana Roo C.P. 77508, Cancún Quintana Roo.

- (998) 184 5446
- Lunes a Viernes 08:30-18:00
Sábado 08:30-15:00

SONORA

PUNTO DE VENTA
Reforma n.º238-A , Colonia Balderrama C.P. 83180, Hermosillo, Sonora.

- (662) 438 7989
- Lunes a Viernes 09:00-18:00
Sábado 09:00-14:00

MONTERREY

DISTRIBUIDOR AUTORIZADO
Av. Francisco I. Madero n.º433 Colonia Centro,C.P. 64000, Monterrey Nuevo León.

- (818) 372 7616
- Lunes a Sábado 10:00-18:30

MORELIA

TIENDA EXCLUSIVA
Av. Madero ote. 2727, Colonia Issac Arriaga, C.P. 58210, Morelia,Michoacán.

- (443) 555 7020
- Lunes a Viernes 09:30-15:00 16:00-18:30
Sábado 09:30-14:00

METEPEC

TIENDA EXCLUSIVA
Tecnológico Metepec No. 1300 Norte, Local 10, Col. Francisco I. Madero, Metepec, Estado de México, C.P. 52172

- (55) 5833 7766
- Lunes a Viernes 10:00-19:00
Sábado 10:00-16:00

METEPEC

TIENDA EXCLUSIVA
Tecnológico Metepec No. 1300 Norte, Local 10, Col. Francisco I. Madero, Metepec, Estado de México, C.P. 52172

- (55) 5833 7766
- Lunes a Viernes 10:00-19:00
Sábado 10:00-16:00

TLANEPANTLA

PUNTO DE VENTA
Av. De los Maestros #56, Local G, Col. Ampliación Lomas de San Andrés Atenco, Municipio de Tlanepantla de Baz, Edo. Mex. C.P. 54040.

- (55) 5833 7766
- Lunes a Viernes 10:00-19:00
Sábado 10:00-16:00

METEPEC

TIENDA EXCLUSIVA
Tecnológico Metepec No. 1300 Norte, Local 10, Col. Francisco I. Madero, Metepec, Estado de México, C.P. 52172

- (55) 5833 7766
- Lunes a Viernes 10:00-19:00
Sábado 10:00-16:00

TLANEPANTLA

PUNTO DE VENTA
Av. De los Maestros #56, Local G, Col. Ampliación Lomas de San Andrés Atenco, Municipio de Tlanepantla de Baz, Edo. Mex. C.P. 54040.

- (55) 5833 7766
- Lunes a Viernes 10:00-19:00
Sábado 10:00-16:00



JWJ COMERCIAL MÉXICO S.A. DE C.V.

Dr.Lavista 127, Col. Doctores, Alc. Cuauhtémoc,
C.P. 06720, Ciudad de México.

Atención a clientes: (55) 5566 7777

Cotizaciones: +52 55 43456035

Horarios de atención:

Lunes a Viernes 09:00-18:00

Sábados 09:00-14:00

¡Síguenos en redes!



www.jwjlight.mx

Distribuidores autorizados

نسن® | **Emerge Lux**